



FITTING INSTRUCTIONS

Part Number: 3580030

Product TWIN/SINGLE COMPRESSOR MOUNTING BRACKET

Description:

Requires:

CKMTA12 - COMPRESSOR KIT TWIN 12V

171503 - MANIFOLD KIT CKMTA

0740112 - HOSE COUPLING NPT

CKMA12 - COMPRESSOR KIT 12V

Suited to FORD BRONCO
vehicle/s:

WARNING

ALSO, NOTE THE FOLLOWING:

- ◆ This product must be installed exactly as per these instructions using only the hardware supplied.
- ◆ Do not use this product for any vehicle make or model, other than those specified by ARB.
- ◆ This product or its fixing must not be modified in any way.
- ◆ The installation of this product may require the use of specialized tools and/or techniques.
- ◆ It is recommended that this product is only installed by trained personnel.
- ◆ These instructions are correct as at the publication date. ARB Corporation Ltd. cannot be held responsible for the impact of any changes subsequently made by the vehicle manufacturer.
- ◆ During installation, it is the duty of the installer to check correct operation/clearances of all components.
- ◆ Work safely at all times.
- ◆ Unless otherwise instructed, tighten fasteners to specified torque.

ARB 4x4 ACCESSORIES

Corporate Head Office

42-44 Garden St
Kilsyth, Victoria
AUSTRALIA 3137

Tel: +61 (3) 9761 6622
Fax: +61 (3) 9761 6807

Australian enquiries
North & South American enquiries
Other international enquiries

sales@arb.com.au
sales@arbusa.com
exports@arb.com.au

www.arb.com.au

GENERAL CARE AND MAINTENANCE

By choosing an ARB Compressor Accessory, you have bought a product that is one of the most sought after 4WD products in the world. Your Accessory is properly engineered, reliable, quality accessory that represents excellent value. To keep your Accessory in original condition it is important to care and maintain it following these recommendations:



- As part of any Pre Trip Preparation, or on an annual basis, it is recommended that a thorough visual inspection of the vehicle's accessories is carried out, making sure that all bolts and other components are torqued to the correct specification. Also check that all wiring sheaths, connectors, and fittings are free of damage. Replace any components as necessary. This service can be performed by your local authorized ARB Stockist.

FITTING REQUIREMENTS

REQUIRED TOOLS FOR FITMENT OF PRODUCT:

BASIC TOOL KIT	TORQUE WRENCH
ROLL OF ELECTRICAL WIRE	HAND DRILL
METRIC DRILL KIT	TAPE MEASURE
SOCKET SET	THREAD SEALANT

HAVE AVAILABLE THESE SAFETY ITEMS WHEN FITTING PRODUCT:

Protective eyewear		Hearing protection	
--------------------	---	--------------------	---

NOTE: 'WARNING' notes in the fitting procedure relate to OHS situations, where to avoid a potentially hazardous situation it is suggested that protective safety gear be worn or a safe work procedure be employed. If these notes and warnings are not heeded, injury may result.

FASTENER TORQUE SETTINGS:

SIZE	Torque Nm	Torque lbft
M6	9Nm	7lbft
M8	22Nm	16lbft
M10	44Nm	32lbft

PARTS LISTING

APPLICATION.	PART NO.	QTY	DESCRIPTION
FIT COMPRESSOR REAR MOUNT	3759081	1	ASSY WELD NUT T6 RP
	4655173	1	WELD ASSY CMPRSR R SUIT BRONCO
	4655174	1	WELDMENT SPRT PIPE SUIT BRONCO
	6151555	1	BOLT HXHD M10x1.5x30 PC8.8 BTZP480 SEMS
FIT COMPRESSOR FRONT MOUNT	180302	1	CABLE TIE 4.8 X 180 MM BLACK
	4655171	1	WELD U BOLT CHANNL SUIT BRONCO
	4655172	1	WELD ASSY CMPRSR F SUIT BRONCO
	6151897	2	BOLT HXHD FL M10x1.5x30 PC8.8 ZNN480
FIT MANIFOLD BRACKET	3753305	1	BRKT CMPRSR MNIFLD SUIT BRONCO
	4584378	4	WASHER FLAT M6x16x1.2 HV300 BTZP480
	6151173	4	NUT FLANGE M6 ZNB480 SERRATED
	6151402	4	BOLT HXHD M6x1.0x16 PC8.8 BZP
FIT COMPRESSOR MOUNTING PLATE	180302	1	CABLE TIE 4.8 X 180 MM BLACK
	3753302	1	BRKT BASE CMPRSR SUIT BRONCO
	4584378	3	WASHER FLAT M6x16x1.2 HV300 BTZP480
	6151173	3	NUT FLANGE M6 ZNB480 SERRATED
	6151550	3	BOLT HXHD M6x1.0x25 PC8.8 BTZP480
	6151730	5	BOLT HXHD FL M8x1.25x20 FT PC8.8 BZP480 ENS14-001
FIT COMPRESSOR MOUNTING PLATE	180302	4	CABLE TIE 4.8 X 180 MM BLACK
	3753306	1	BRKT WHEEL LINER SUIT BRONCO
	4584378	2	WASHER FLAT M6x16x1.2 HV300 BTZP480
	6151173	2	NUT FLANGE M6 ZNB480 SERRATED
	6151402	2	BOLT HXHD M6x1.0x16 PC8.8 BZP
	6151596	2	P CLIP 19MM

FITTING PROCEDURE

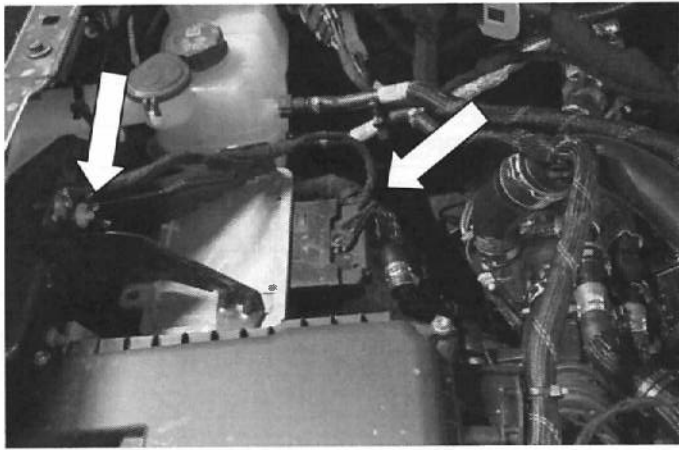

1. Unplug the DLCM and remove the two M6 bolts holding the mount to the body. **DO NOT DROP.**
2. Remove and discard harness plug and earthing harness.

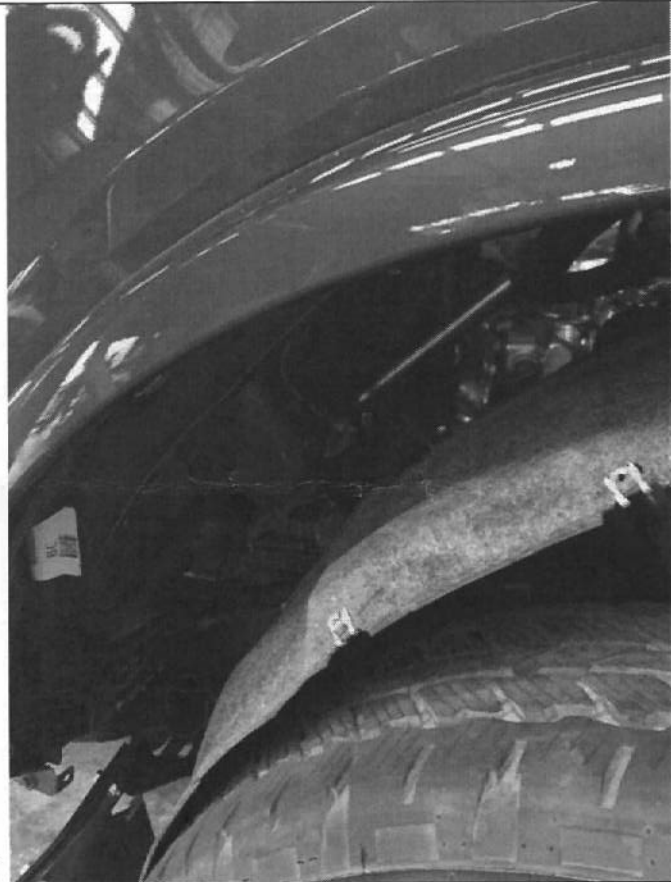
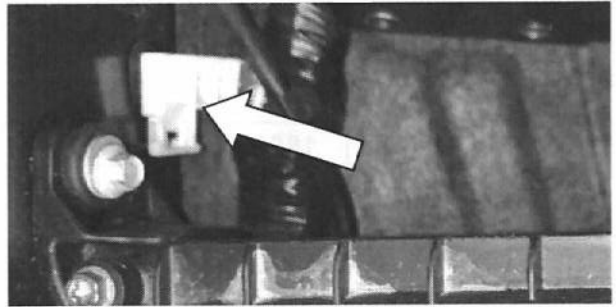

3. Remove fasteners (rear half only) for RHS inner guard and lower.

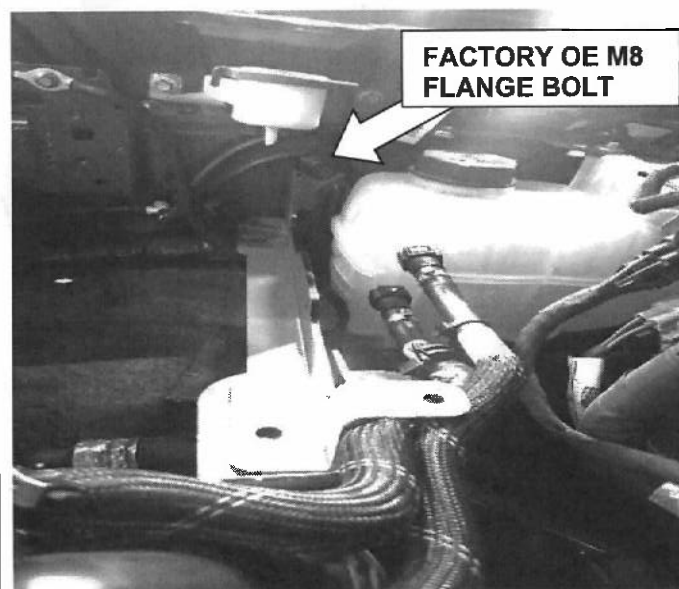

4. Fit the rear support bracket (4655173) using the factory OE M8 flange bolt. Leave loose at this stage.

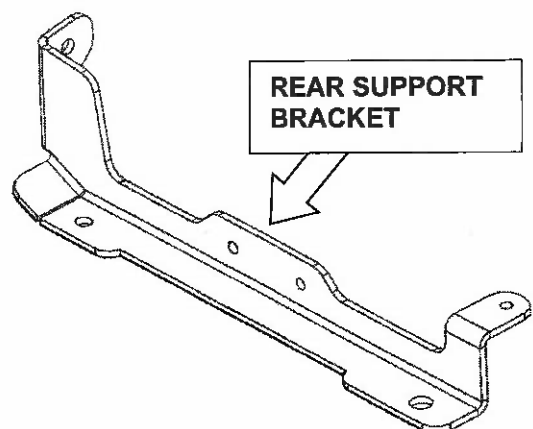

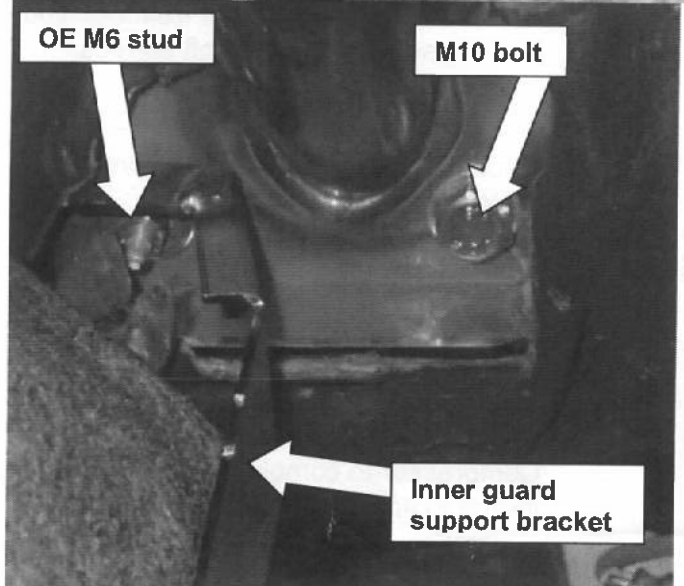
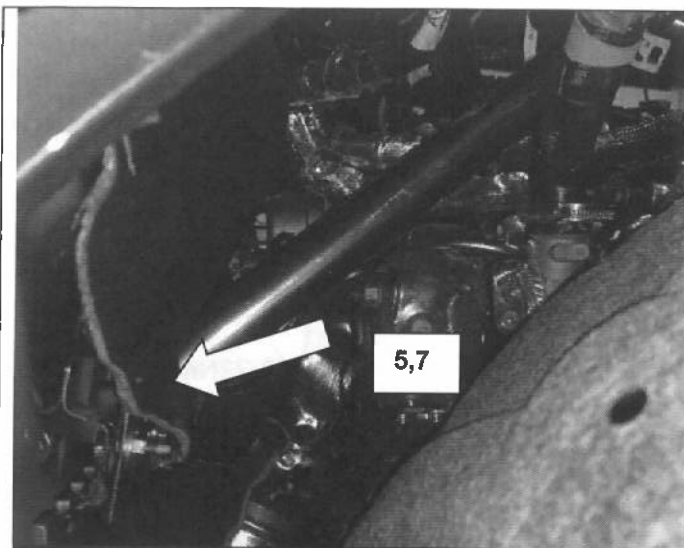

5. Feed support tube weldment to the firewall and locate onto the M6 stud. Once on, place the inner guard support bracket over the same OE factory stud, and fasten OE M6 nut.

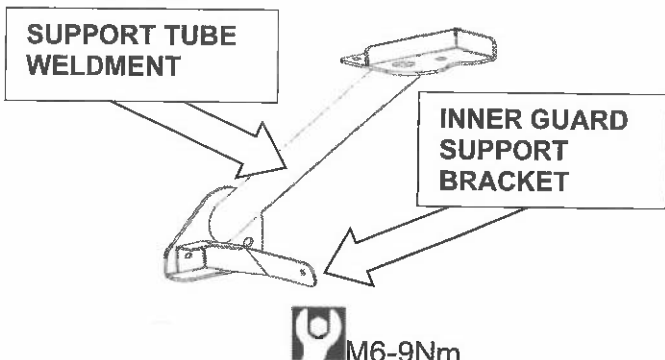

 M6-9Nm

6. Use an M8 FL BOLT to temporarily brace the support tube to the rear support bracket.
7. Using the M10 Nut stick (bent profile shown below) and one M10 SEMS bolt, fix the support arm to the firewall. Ensure to remove or tuck away the excess ends of nut stick tails to prevent any rattling.

 M10-44Nm

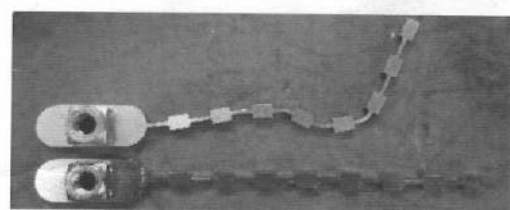

8. Once support arm is fixed, remove M8 bolt from step 6.

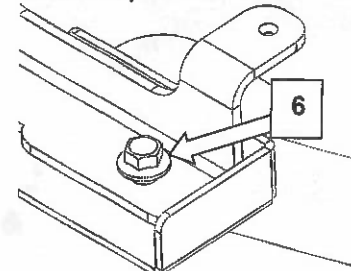

9. Feed the U BOLT CHANNEL behind the chassis from the top
- Note: the notch in the part faces towards the top.

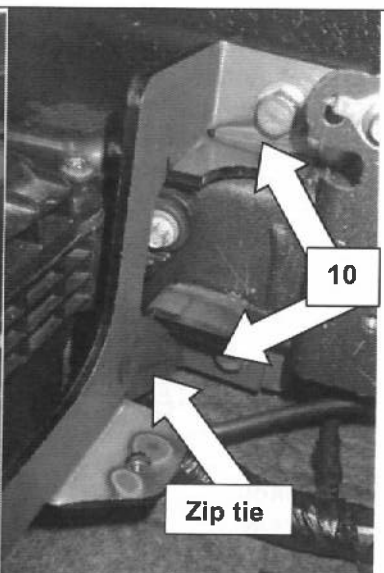
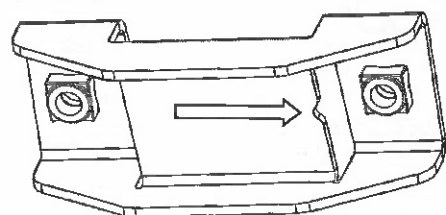

10. Fasten the front support bracket to the U channel with two M10 FL bolts. Leave loose at this stage
11. Support Wiring harness to mount with a Zip Tie.

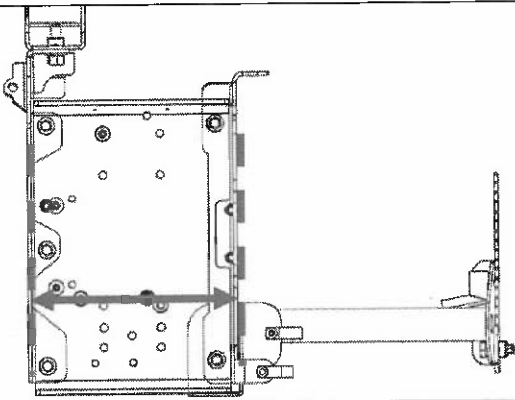

12. Measure outside to outside of the two support brackets. They should measure 220mm. If not, adjust accordingly.
13. Tighten M10 FL bolts.

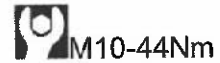

14. Tighten factory OE M8 flange bolt from step 4.



TWIN COMPRESSOR INSTALLATION, CONTINUE. SINGLE COMPRESSOR, SKIP TO STEP 44.

15. Remove Twin Compressor from box and place upside down on a soft surface.

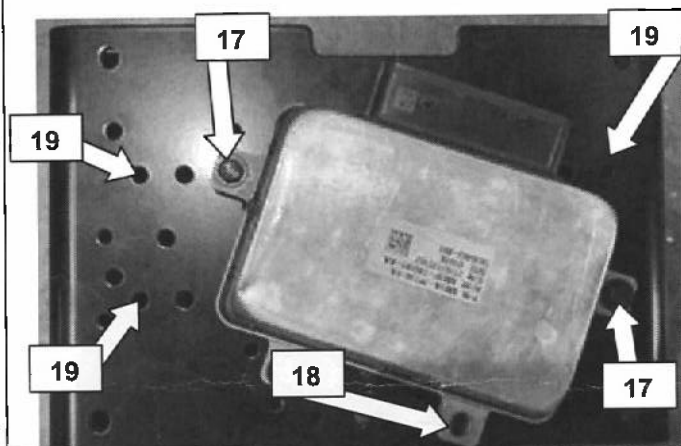

16. Place base plate onto the Compressor along with the DLCM.
17. Using two M6 x 25 bolts, two M6 Flat washers attach the DLCM to the Compressor.
18. Use one M6 x 25, one M6 Flat washer and one M6 FL nut on the third position of the DLCM.
19. Use three fasteners supplied with the Compressor to complete the mounting, and torque to spec.

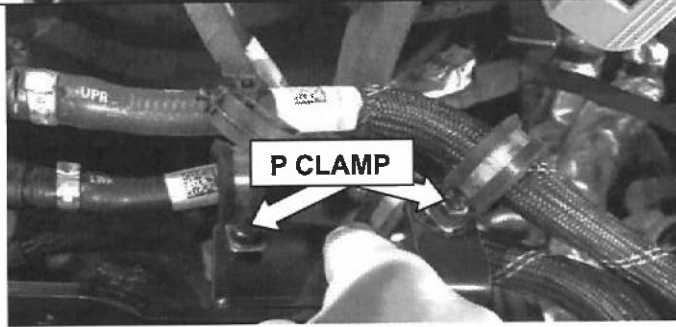

20. Secure the coolant hoses with two P clamps, M6x16mm bolts, washers, and flange nuts.

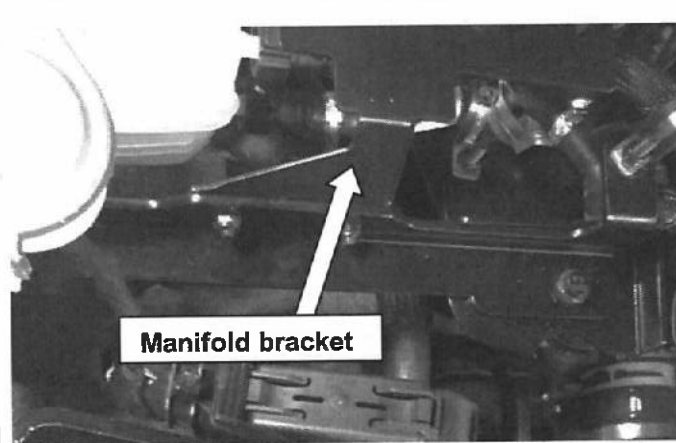
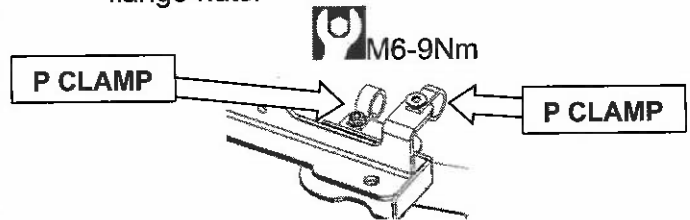

21. Using 2 x M6 x 16 bolts, washers and flange nuts, fit the Compressor Manifold bracket to the rear mount.
22. Fit the Manifold feet to the manifold mounting bracket using M6x16 bolts, washers and flange nuts.

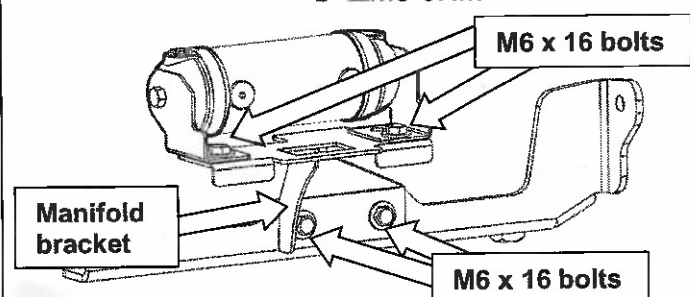
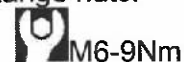

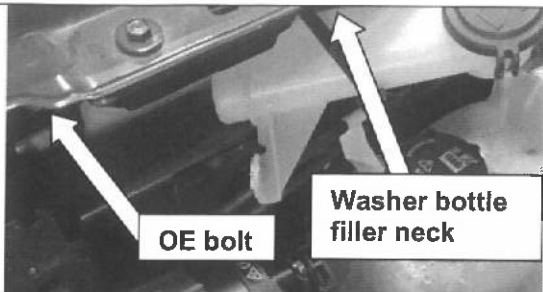

23. Temporarily remove the washer bottle filler neck by removing the bolts retaining it to the vehicle body.



24. Carefully install the assembled Compressor, base plate and DLCM onto the support brackets.
 25. Use 5 x M8 FL BOLTS to secure the base mounting plate to the Front and Rear support brackets.

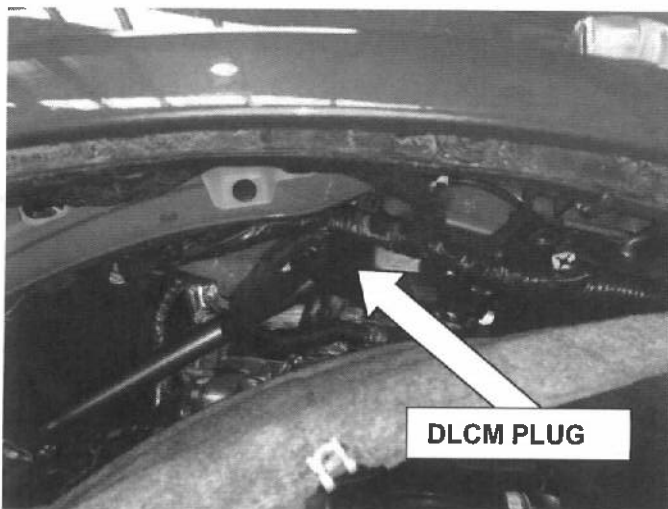

26. Reinstall washer bottle filler neck
 27. Plug in the DLCM by gaining access through the inner guard.
 28. Reinstall inner guard.

Note: Ensure to install OE scrivet into ARB inner guard support bracket.

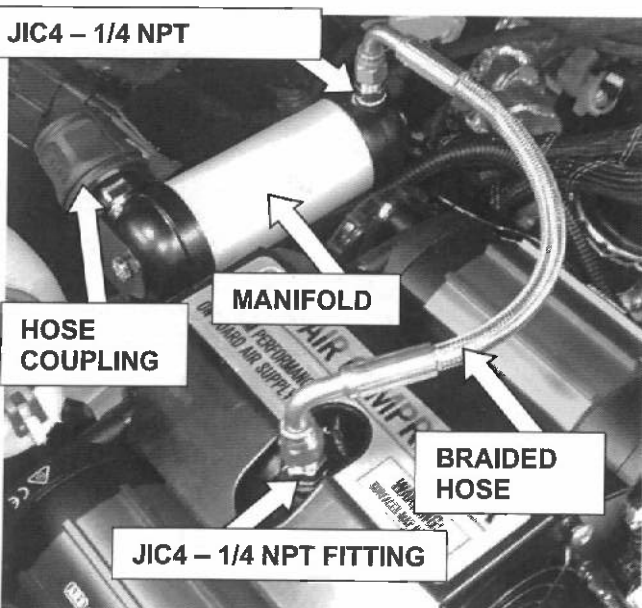
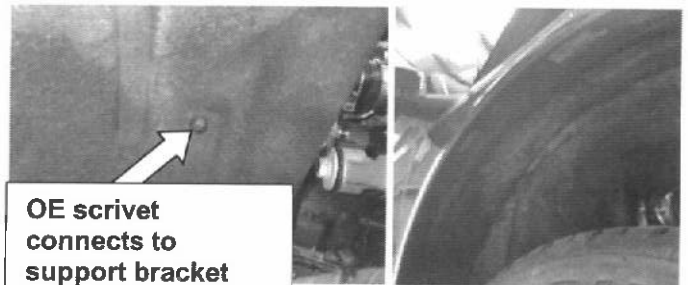

29. Using the fittings provided in the kit 171503, fit 1 x JIC4 - 1/4 NPT fitting to the inboard manifold port (as shown in the image to the left).

Note: Ensure to use thread sealant on the 1/4 NPT threads.

30. Repeat the same process for the compressor outlet port.
 31. Connect manifold to the compressor using the braided hose and tighten.
 32. Attach the hose coupling (0740112) to the outboard port on the manifold (as seen in the image to the left).

WIRING PROCEDURE

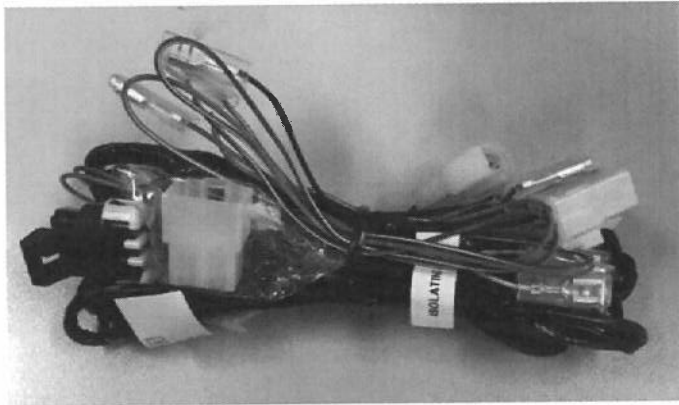

33. Using the wiring harness 180415, measure and cut 400mm of wire (purple/black) connected to the purple plug.
 Note: Ensure the plug is retained (as shown below)

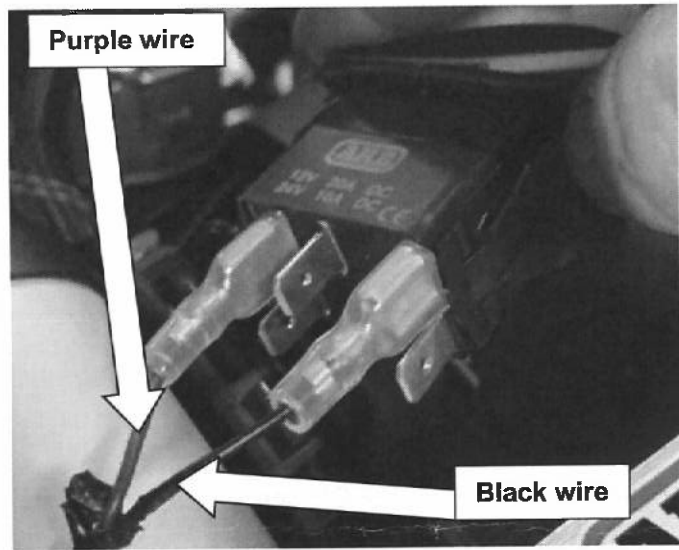
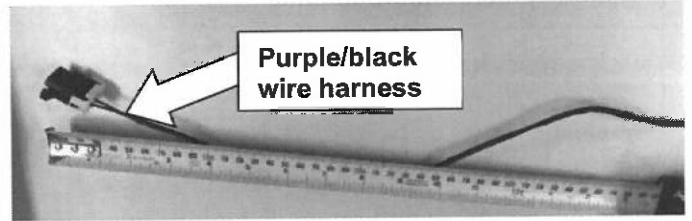

34. Connect spade connectors to the cut ends.
 35. Connect spade connectors to the switch pins as followed:

Color	Switch Pin
Black	8
Purple	3

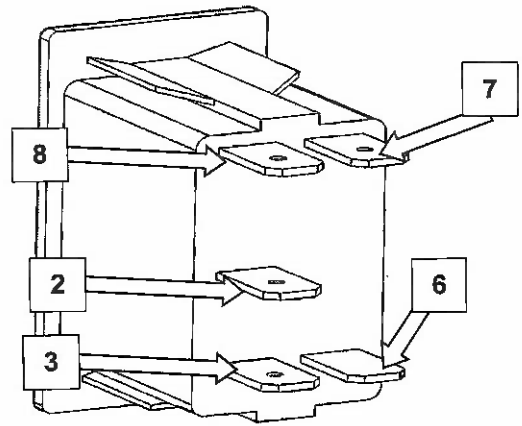

36. Pickup power from the stability bar module fuse (10A) located in the engine bay fuse box. Fuse reference #158 in owners manual.

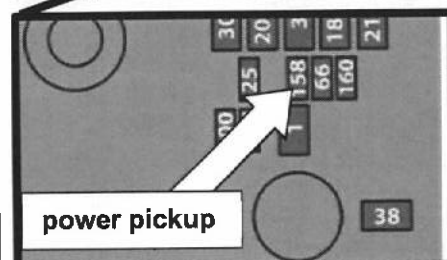
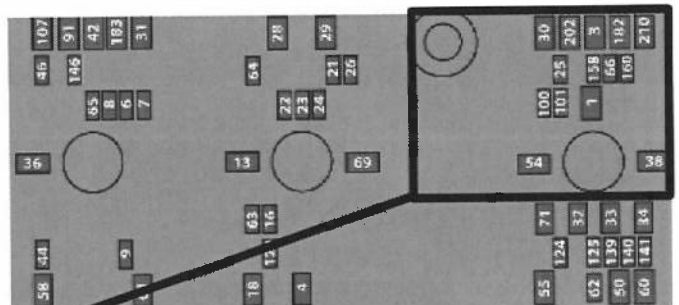

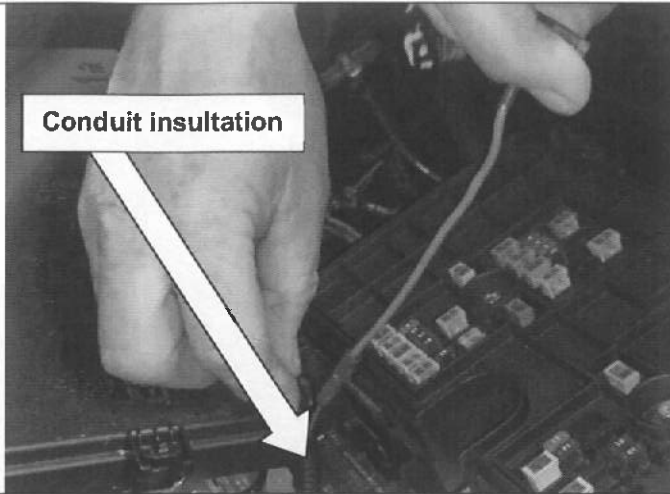

37. Run wiring around the rear section of engine bay to the compressor switch.
Note: Ensure to insulate the wiring in conduit.

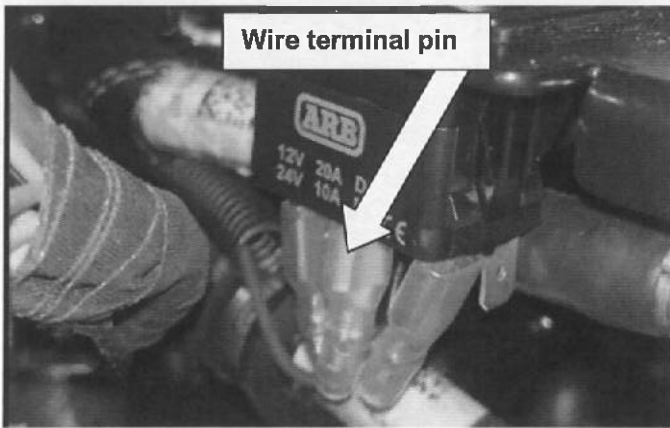

38. Connect spade connectors from wire to switch pin 2.

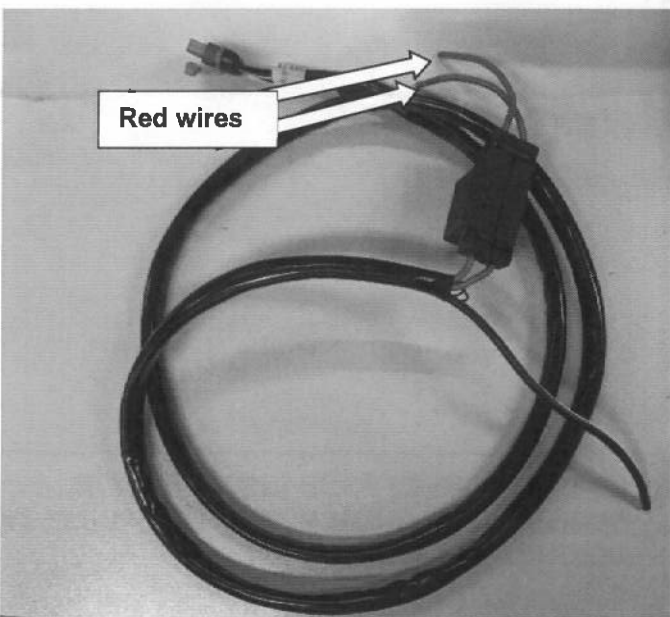

39. Crimp a terminal to the end of each of the two red wires on the compressor wiring harness (pn 180414), and then connect to positive battery terminal.

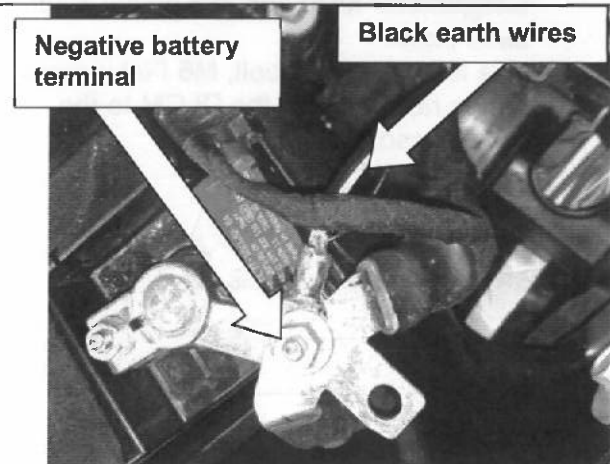
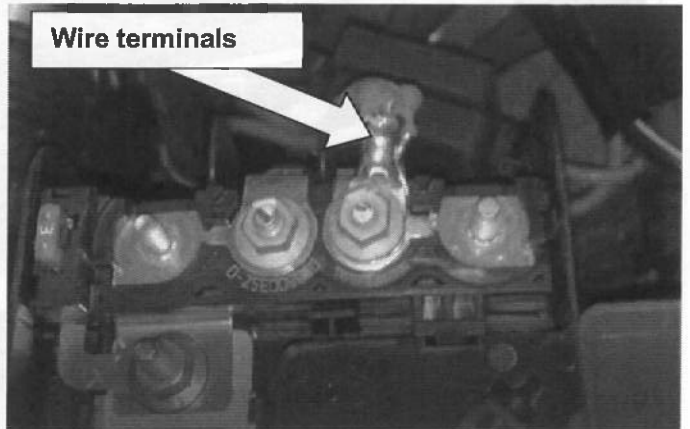

40. Connect up the 2 black earth wires from the compressor wiring harness to the negative battery terminal.

41. Route the harness around the back of the engine bay. Cable tie every 400mm.

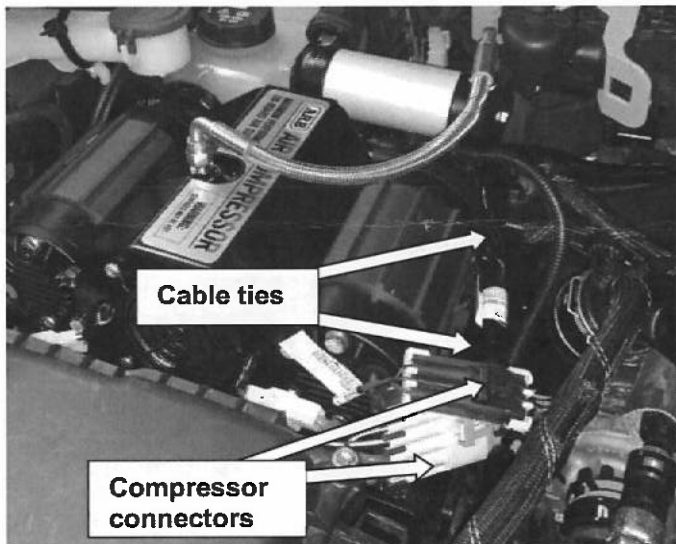
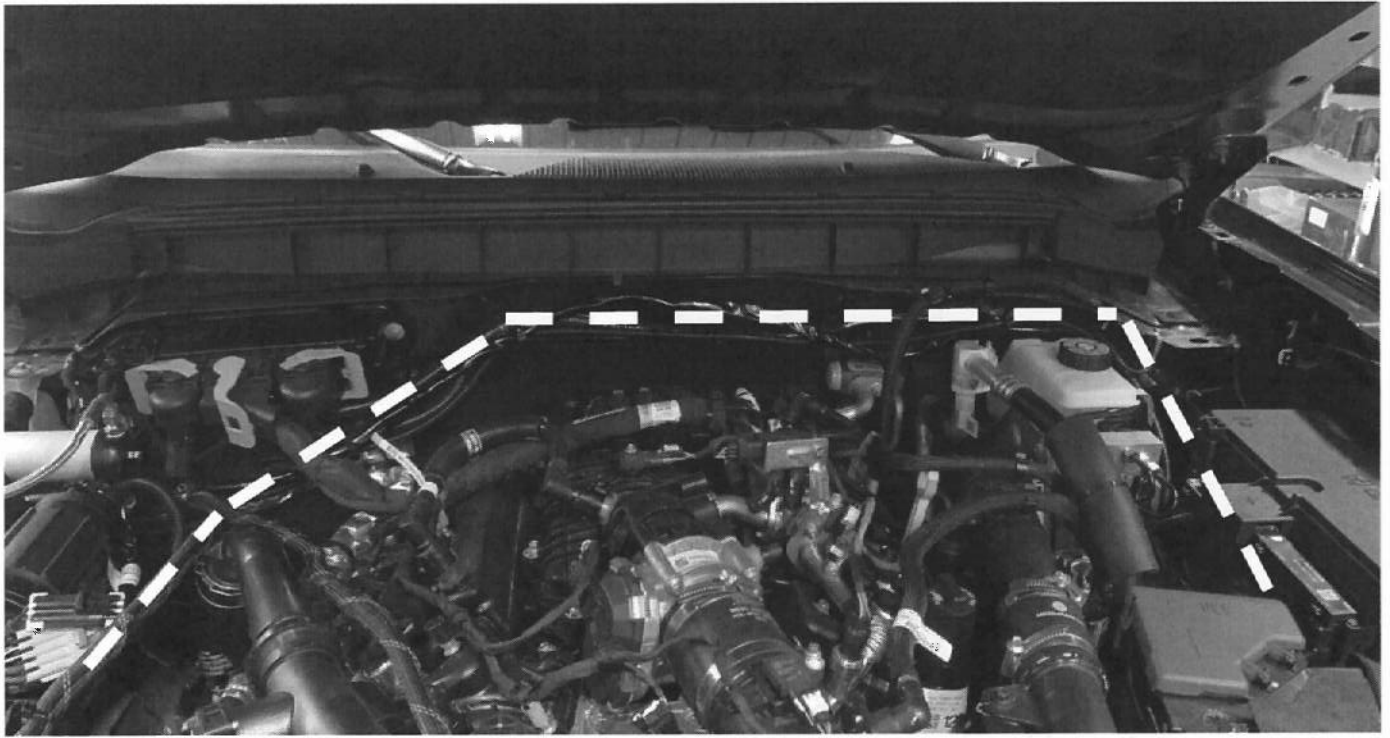

- 42. Plug the two harnesses into the compressor connectors.
- 43. Cable tie the harness to the base plate.

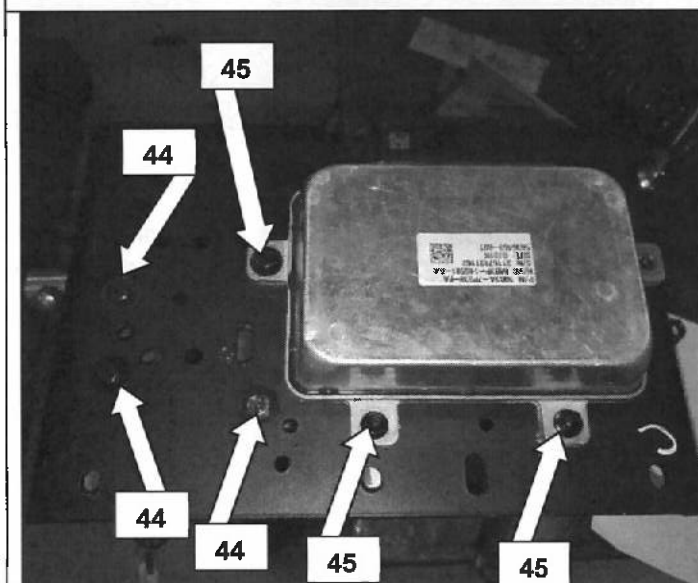

SINGLE COMPRESSOR INSTALLATION, CONTINUE ON FROM HERE, OTHERWISE SKIP TO END.

- 44. Use three fasteners supplied with the Compressor kit to connect compressor to base plate.
- 45. Use three M6 x 25 bolt, M6 Flat washer and flange nut to attach the DLCM to the Compressor.

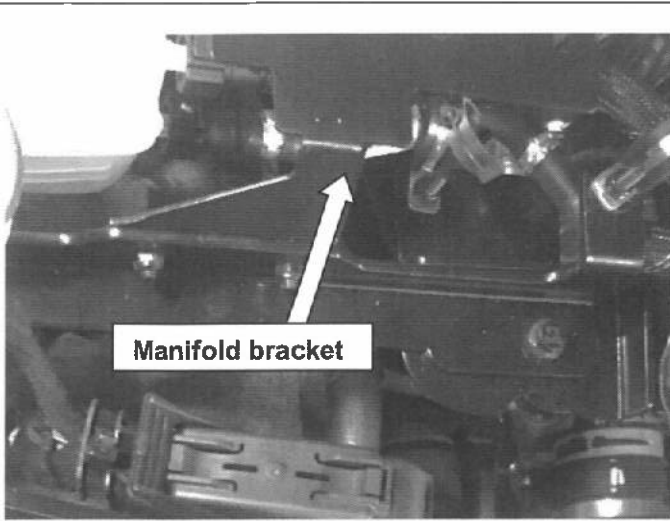

Manifold bracket

46. Using 2 x M6 x 16 bolts, washers and flange nuts, fit the Compressor Manifold bracket to the rear mount.
47. Fit the Manifold feet to the manifold mounting bracket using M6x16 bolts, washers and flange nuts.

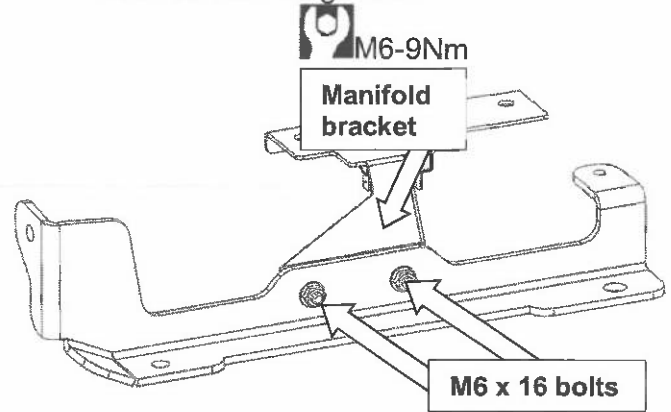

M6-9Nm

Manifold bracket

M6 x 16 bolts



48. Plug the DLCM in.

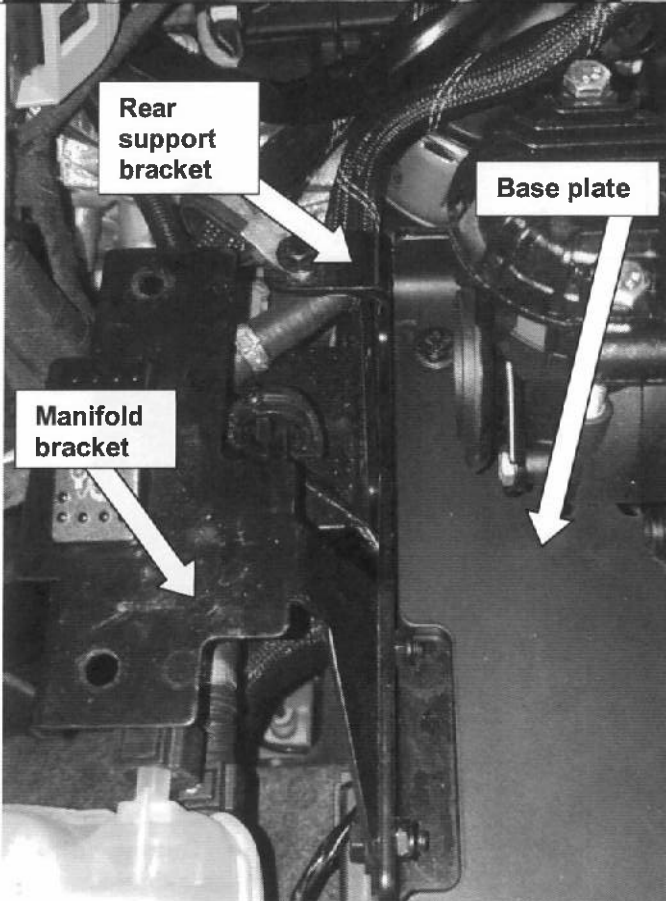

Rear support bracket

Base plate

Manifold bracket

49. Loosen the factory flange bolt from step 8, and rotate rear support bracket, and place between the base plate and DLCM.

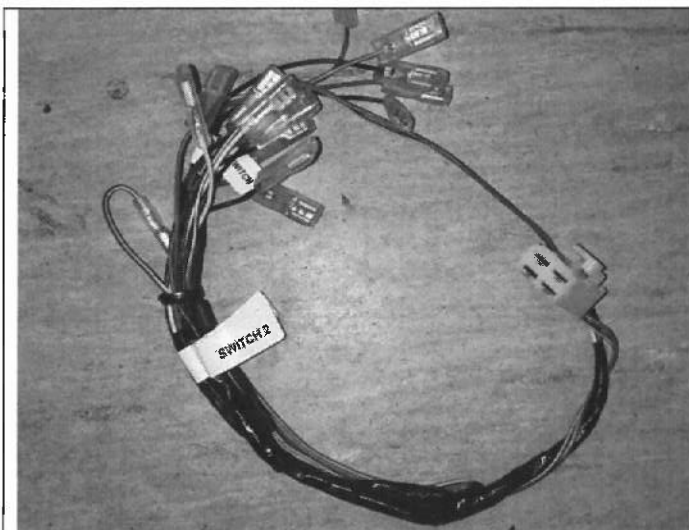

50. Discard this section of wiring.

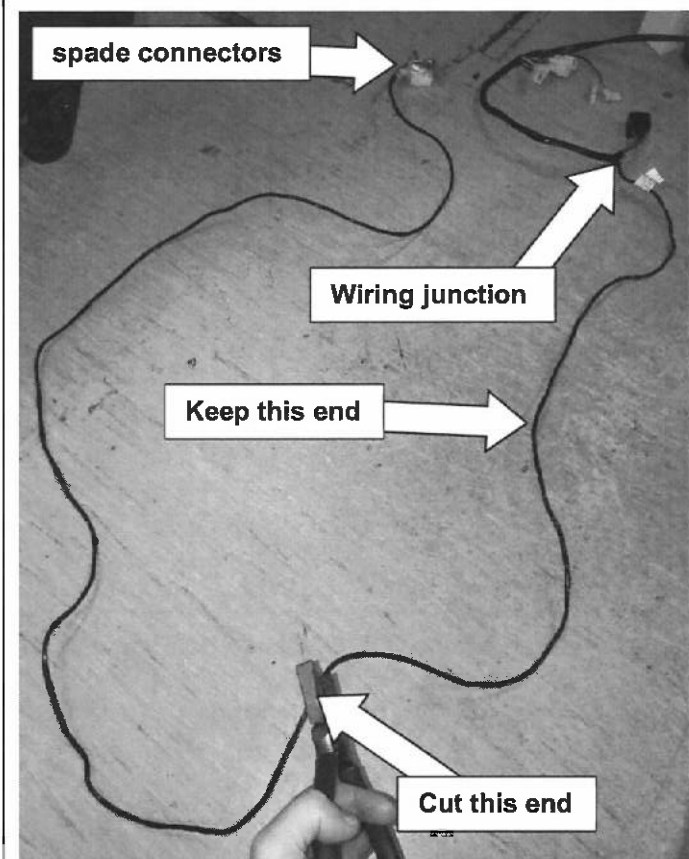

51. Using the wiring harness 180409, measure (from the junction) and cut the green/red/yellow/black wire to a length of 750mm (cut end with spade connectors).

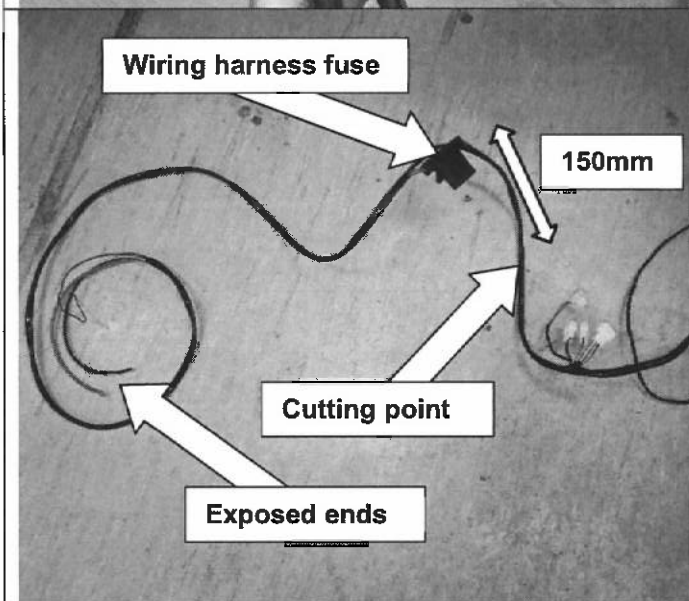
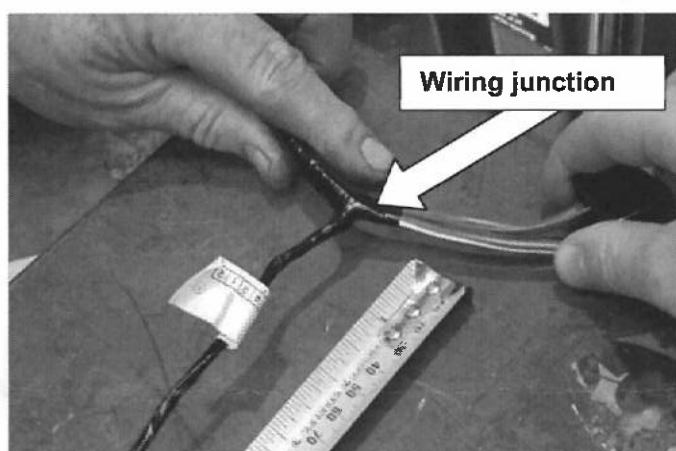

52. With the wiring harness 180409, measure and cut the red and black wire 150mm from the fuse.

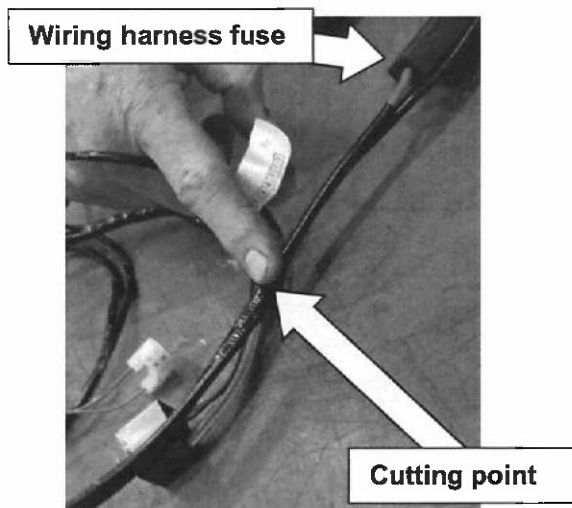

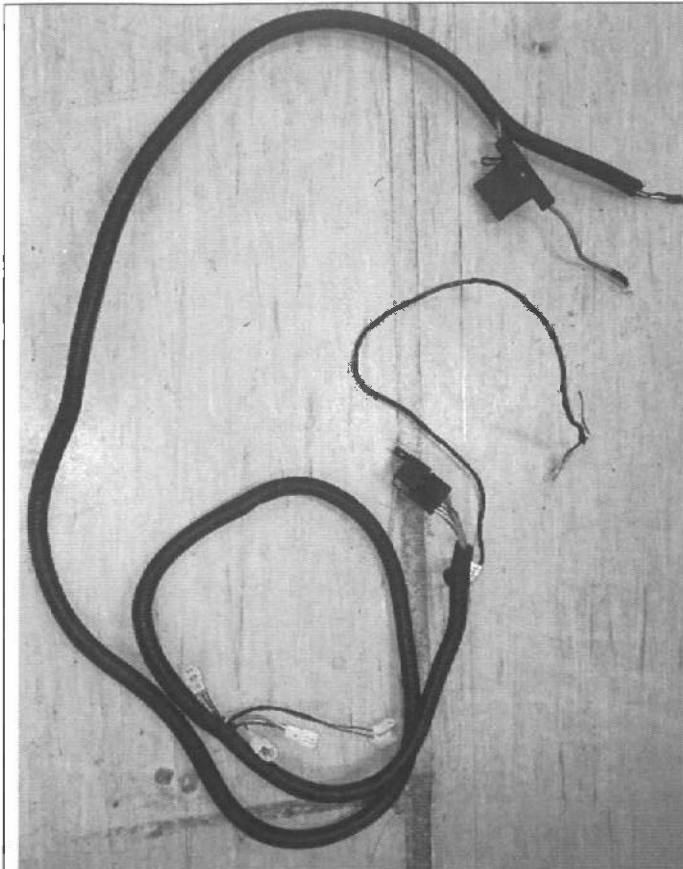

53. With the two cut sections of the wiring harness, reverse and reattach (the section with the fuse) by soldering the exposed ends to the ends of the other section that were cut in the previous step.

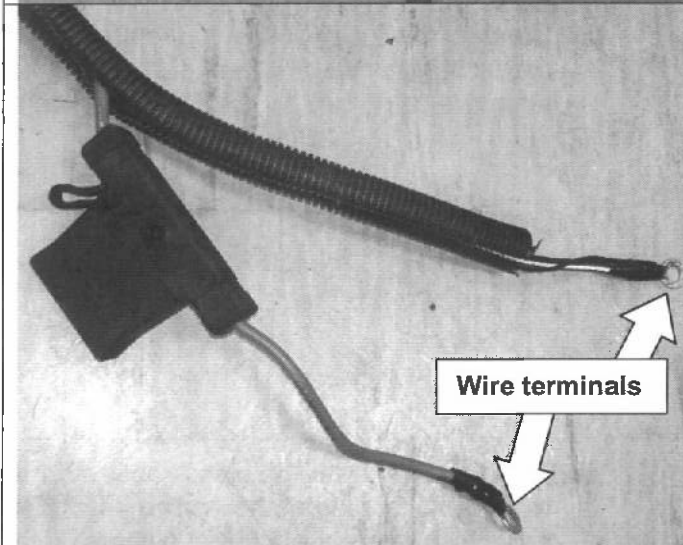

54. Crimp a terminal to the end of each of the two wires on the compressor wiring harness (pn 180409).

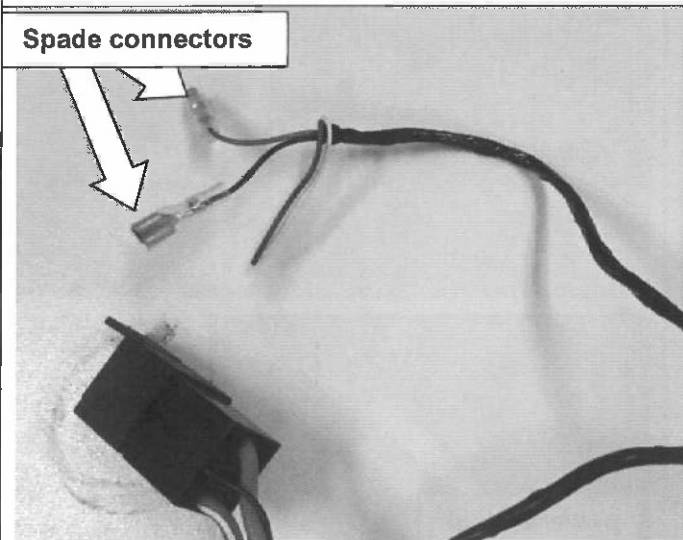
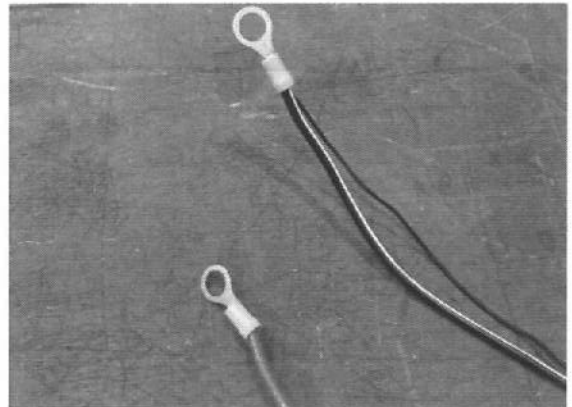

55. Add spade connectors to the red and black wires.

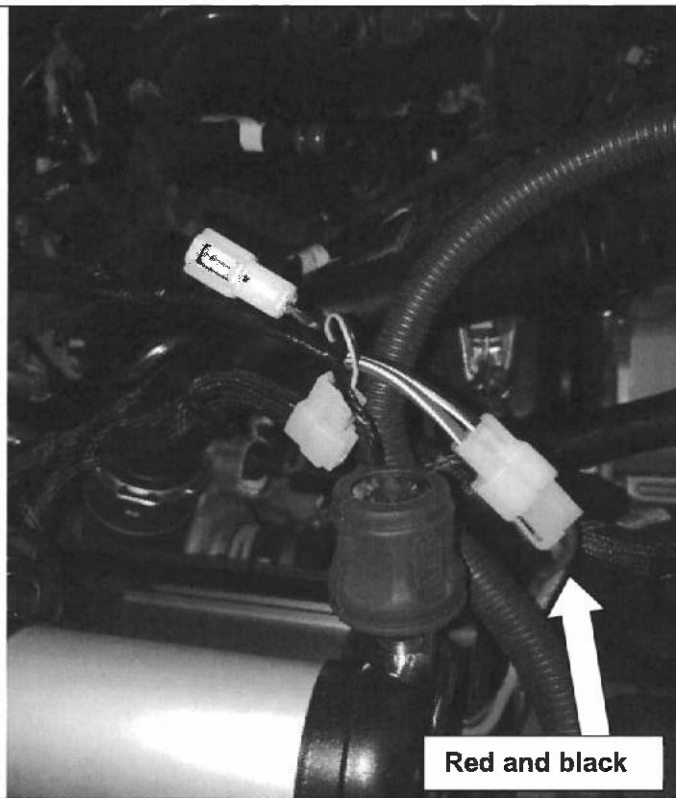

56. Repeat the same routing in step 41.
57. Plug the red and black wires into the compressor plug.

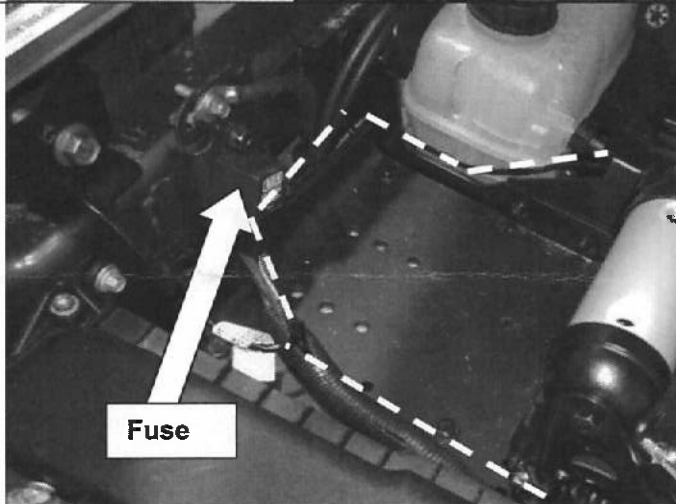

58. Route wiring harness around the base plate.
59. Connect the fuse (C042) to the wiring harness, and mount to wall of hydroformed structure using one M6 bolt and washer.



60. Pickup power from the stability bar module fuse (10A) located in the engine bay fuse box. Fuse reference #158 in owners manual.

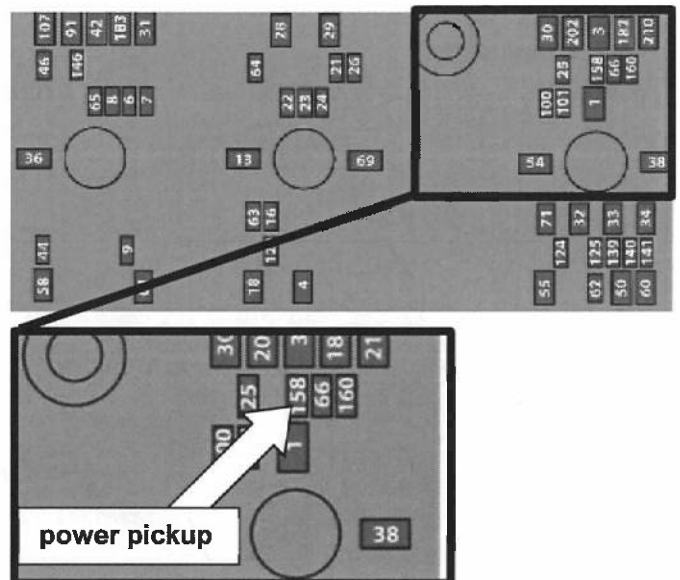

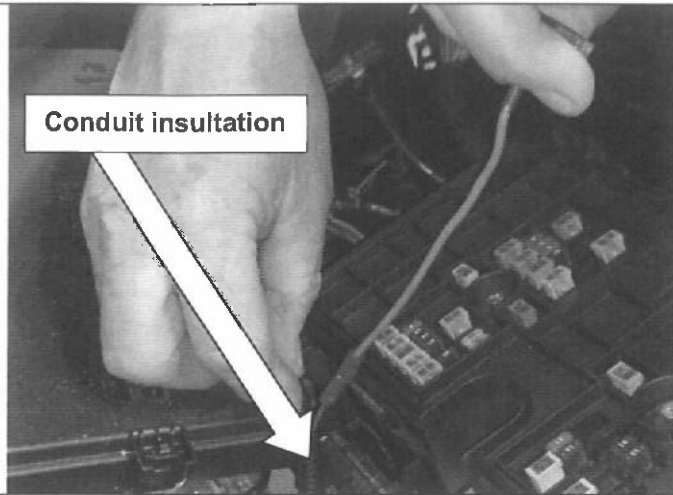

61. Run wiring around the rear section of engine bay to the compressor switch.
 62. Add a spade connector to the opposite end.
 Note: Ensure to insulate the wiring in conduit.

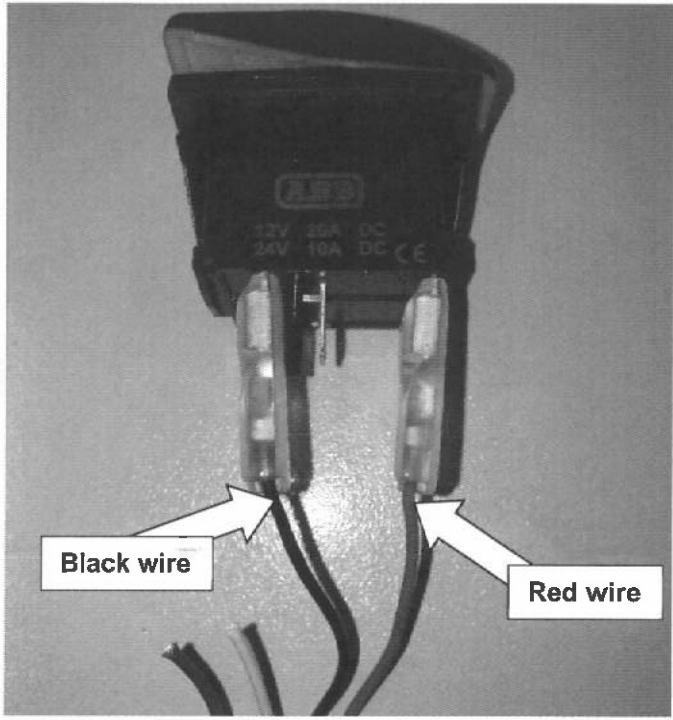

63. Connect spade connectors (from step 55) to the switch pins as follows:

Color	Switch Pin
Black	8
Red	3

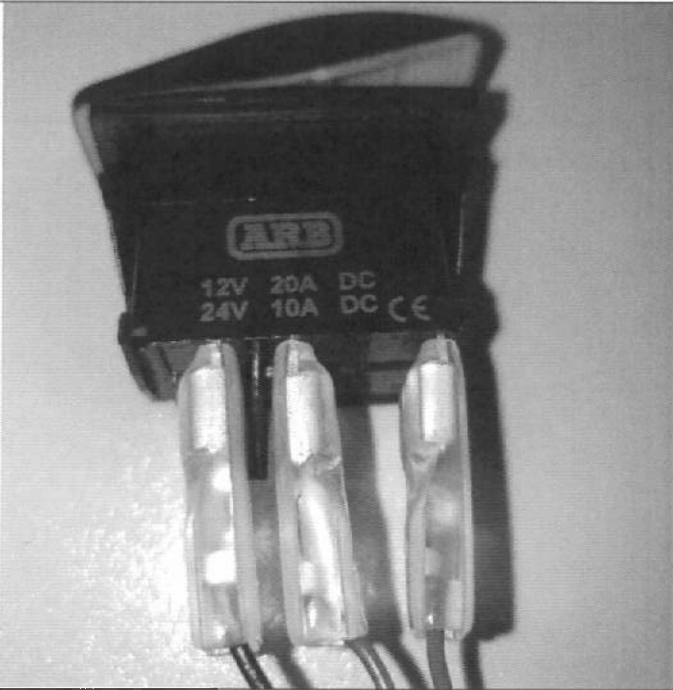
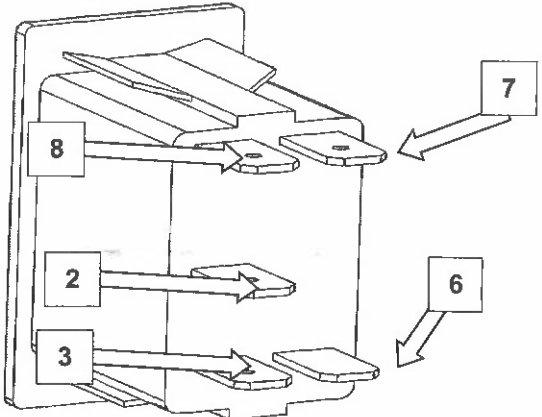

64. Connect the spade connector (from step 62) to switch pin 2.

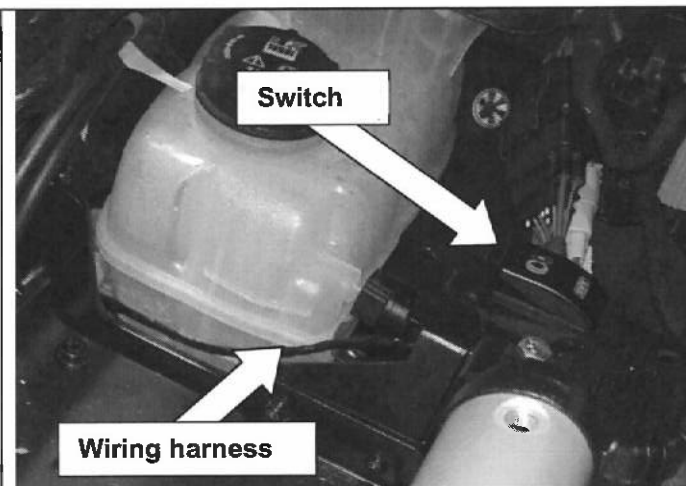

65. Install the switch into the manifold bracket.

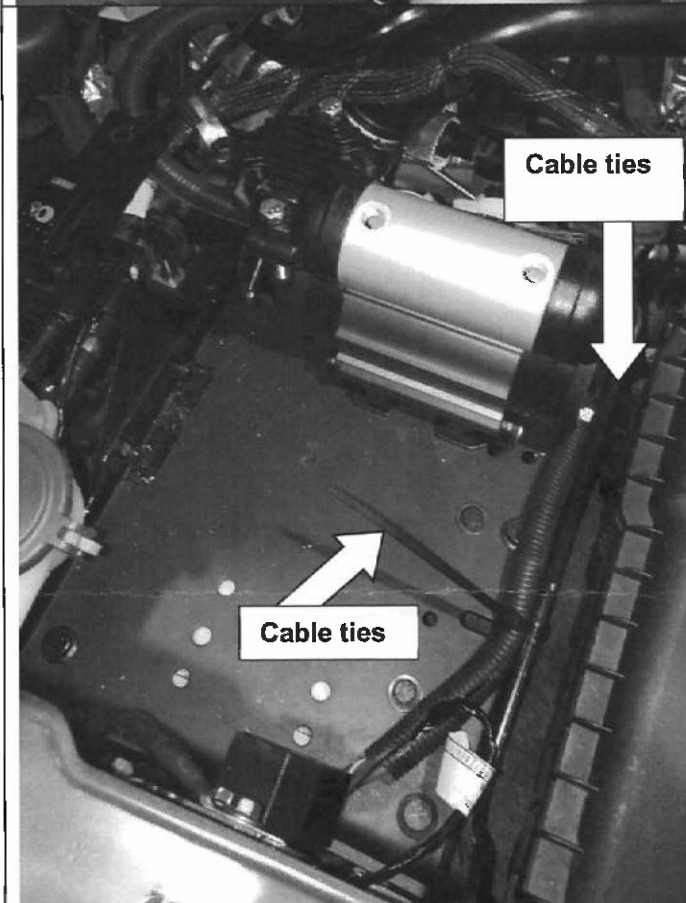
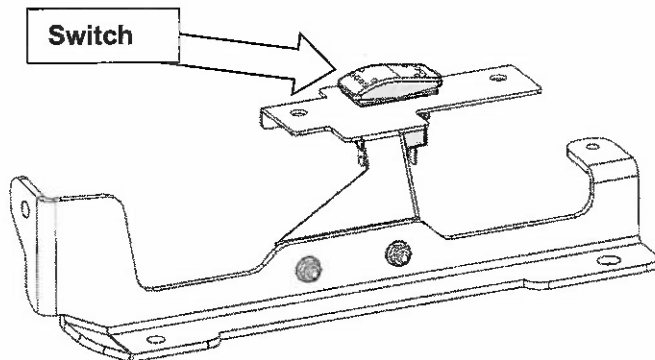

66. Apply cable ties to wiring harness.



67. Install pressure switch and air chuck.

FITTED PRODUCT

TWIN COMPRESSOR

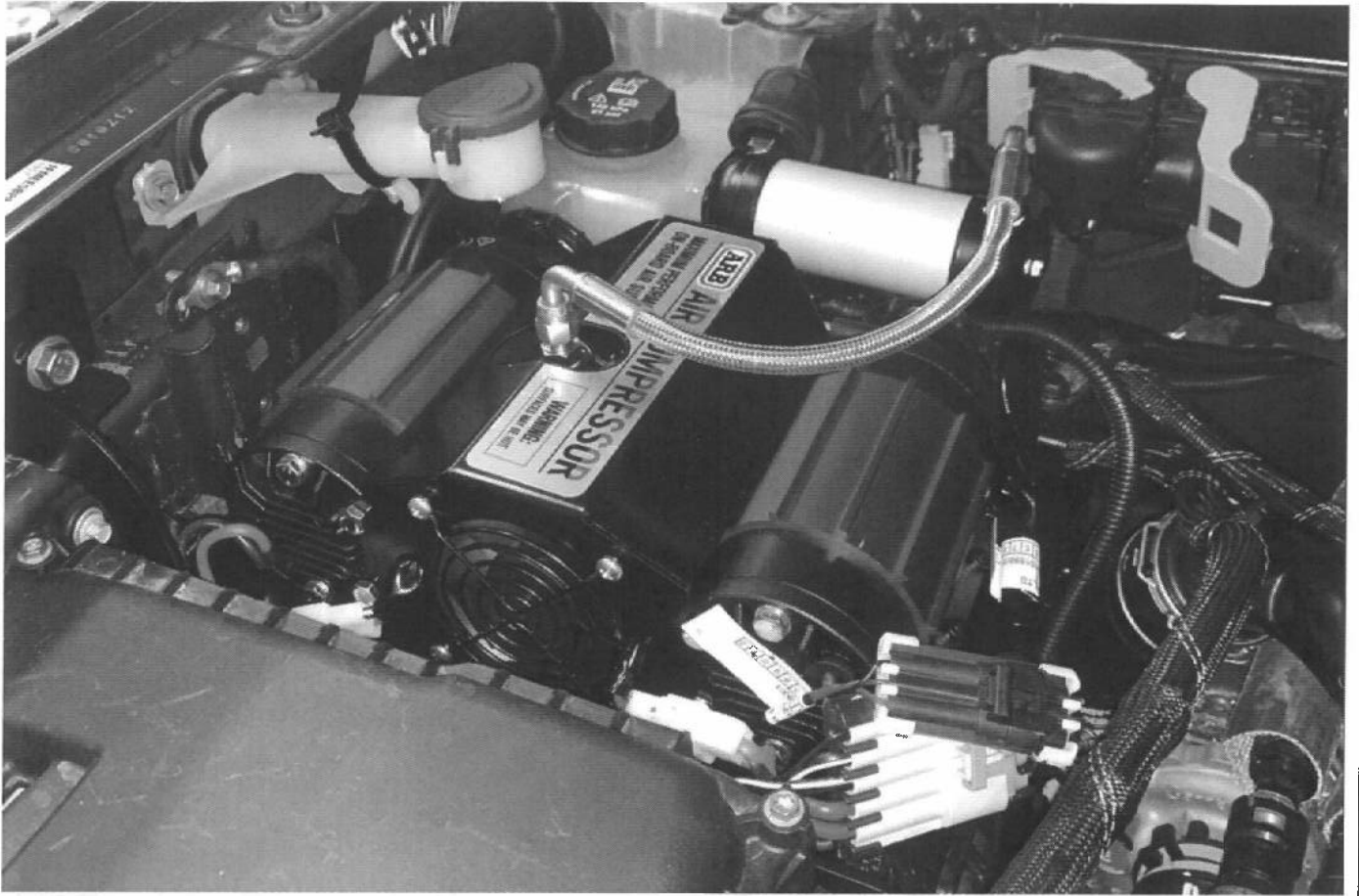

SINGLE COMPRESSOR

