

THE POWER OF

REDARC®

In-vehicle DC Power Supply

**DPS1225, DPS1240,
DPS2410 & DPS2420**

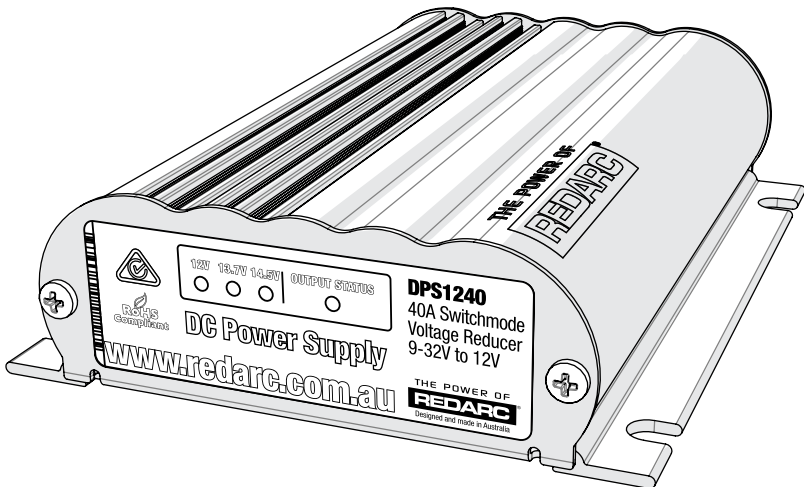

THE DPS1225, DPS1240, DPS2410 & DPS2420

The DPS series In-vehicle DC Power Supplies feature technology designed to supply 12 V or 24 V (model dependent) electrical loads such as lamps, radios, small motors, computer and communications equipment, fridges, pumps and TVs from a 12 V or 24 V automotive power system.

1 WARNING & SAFETY INSTRUCTIONS

SAVE THESE INSTRUCTIONS - This manual contains IMPORTANT SAFETY INSTRUCTIONS for the DPS1225/DPS1240/DPS2410/DPS2420 DC Power Supplies.

DO NOT OPERATE THE Power Supply UNLESS YOU HAVE READ AND UNDERSTOOD THIS MANUAL AND the Power Supply is installed as per these installation instructions.

⚠ WARNING

DO NOT USE THE DPS1225/DPS1240/DPS2410/DPS2420 TO CHARGE BATTERIES. DOING SO MAY RESULT IN HARM TO THE USER AND/OR DAMAGE TO THE DPS1225/DPS1240/DPS2410/DPS2420.

⚠ CAUTION

1. This appliance is not intended for use by persons (including children) with reduced physical, sensory or mental capabilities, or lack of experience and knowledge, unless they are supervised or have been instructed on how to use the appliance by a person responsible for their safety. Children should be supervised to ensure that they do not play with the appliance.
2. Do NOT alter or disassemble the Power Supply under any circumstances. All faulty units must be returned to REDARC for repair. Incorrect handling or reassembly may result in a risk of electric shock or fire and may void the unit warranty.
3. Check the manufacturers data for your equipment/loads and ensure the maximum voltage of the DPS1225/DPS1240/DPS2410/DPS2420 does not exceed the manufacturers recommended maximum operating voltage.
4. The DPS1225/DPS1240/DPS2410/DPS2420 will achieve best results when proper load and vehicle maintenance is regularly performed.

CONTENTS

1	WARNING & SAFETY INSTRUCTIONS	2
2	SPECIFICATIONS	4
3	FUSING	4
4	PRODUCT FUNCTION	5
4.1	Display Panel	5
4.2	Unit Performance Characteristics	6
4.3	Error Codes	7
5	INSTALLATION	7
5.1	RED wire — Input Source Positive	7
5.2	BLUE wire — Ignition Control	8
5.3	ORANGE wire — Output Voltage Select	8
5.4	BROWN wire — Output load Positive	9
5.5	BLACK wire — Common Ground	9
5.6	GREEN wire — Optional External LED	9
5.7	Earth Isolation	9
5.8	Cable sizing	10
5.9	Wiring	10
5.10	Connecting in Parallel	12
6	TROUBLESHOOTING	13
7	WARRANTY	15

2 SPECIFICATIONS

Part Number	DPS1225	DPS1240	DPS2410	DPS2420
Input Voltage Range	9 to 32 V			
Recommended Input Fuse**	40 A (REDARC FK40 recommended)	60 A (REDARC FK60 recommended)	40 A (REDARC FK40 recommended)	60 A (REDARC FK60 recommended)
Nominal Output Current Rating	25 A	40 A	10 A	20 A
Surge Current Rating	50 A	80 A	20 A	40 A
Recommended Output Fuse**	40 A (REDARC FK40 recommended)	60 A (REDARC FK60 recommended)	40 A (REDARC FK40 recommended)	40 A (REDARC FK40 recommended)
No Load Current	< 100 mA		< 200 mA	
Standby Current	< 5 mA			
Output Voltage (selected with Orange wire)				
No Connection	12.0 V		24.0 V	
Earth	13.7 V		27.4 V	
Positive supply	14.5 V		29.0 V	
Line & Load Regulation	± 1%			
Conversion Efficiency	> 94%			
Operating Temperature	-50°C to +50°C (-58°F to +122°F)			
Weight	680 g (24 oz)			
Dimensions	150 × 120 × 37 mm (5.9 × 4.7 × 1.5")			
Standards	CE, C-Tick, AS/NZS CISPR1 1:2004			
Warranty	2 Years			

*1. Please refer to FUSING below.

Voltage tolerance of ±0.12V.

3 FUSING

REDARC recommend using MIDI style bolt down fuses as they ensure a low resistance connection. The REDARC FK40 and FK60 fuse kits are recommended.

Blade type fuses are not recommended as they can result in a high resistance connection which causes excess heat and may damage the fuse holder and/or the wiring. Self-resetting circuit breakers are not recommended as they may trip prematurely and continue to cycle until failure, due to the heat generated by the current flowing through the wires.

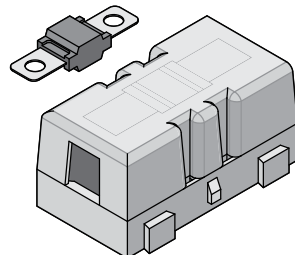

4 PRODUCT FUNCTION

The DPS1225/DPS1240/DPS2410/DPS2420 is a DC-DC power supply designed to run electrical loads. The input voltage of the DPS can be above, below or equal to the output voltage making it ideal for running equipment where specific load voltages or extreme voltage drop are an issue.

The DPS is also designed to isolate the main battery from the load when the vehicle is turned off to avoid flattening the vehicle’s starter battery.

4.1 Display Panel

The front panel features 4 LEDs to display the voltage level and output status.

LED State	‘Voltage Level’ LEDs	‘Output Status’ LED
Off	Unit has no Power	Output is off
Blinking	Unit is in Standby	Unit is supplying power
On	Unit is on and can supply power	

When blinking, the flash duty-cycle of the ‘Output Status’ LED will increase to reflect the amount of current being supplied - If the LED is ON solid, the unit is supplying full power (e.g. 25 A for a DPS1225).

Figure 1: The DPS Series Front Decals

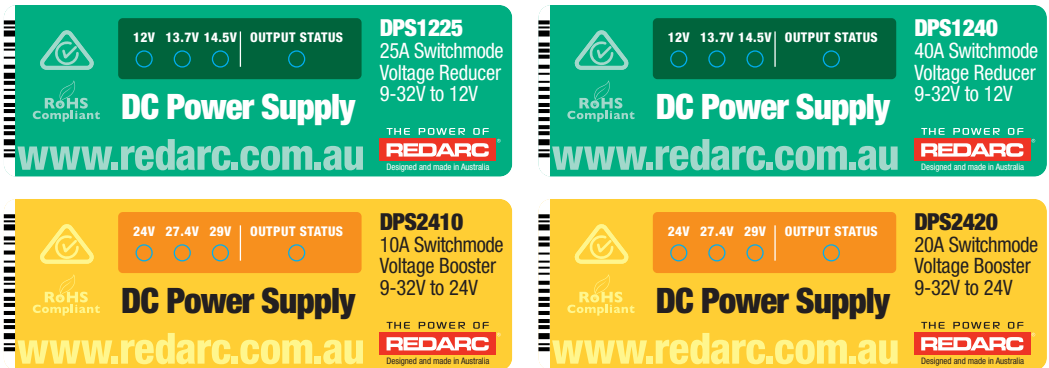

4.2 Unit Performance Characteristics

The DPS Should be mounted to the vehicle’s chassis to allow adequate heat-sinking. If the DPS experiences extreme ambient temperatures its output power may decrease until a steady-state is achieved. Better heat-sinking will enable greater power output.

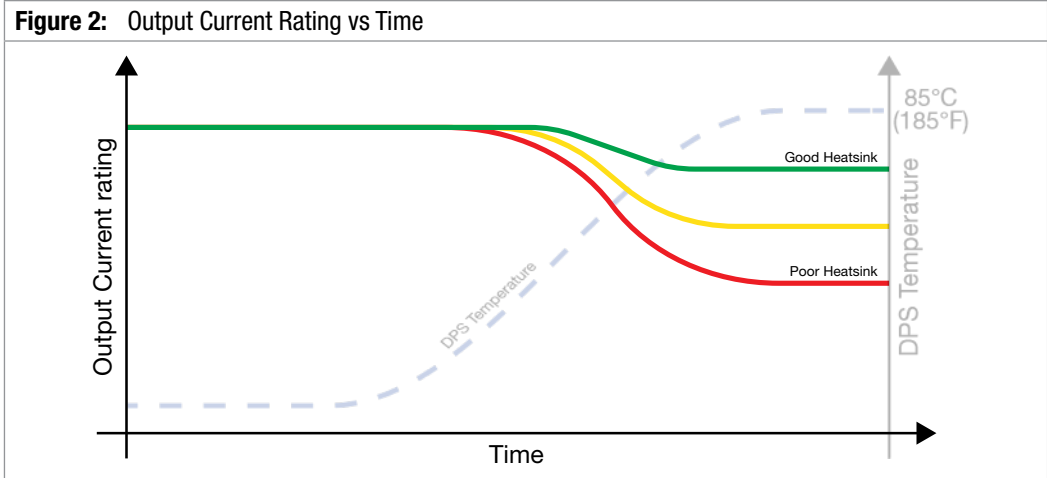

The DPS is able to overcome substantial voltage drop by acting as a voltage booster. Voltage drop (as a result of inadequate input cable size) can cause excessive heat to be generated in the wiring. To ensure the wiring is protected the DPS will try to limit the difference between input and output voltage by reducing the current draw on the input of the unit. To ensure full power output is maintained suitable cable size (as outlined in Section 5.8) should be used.

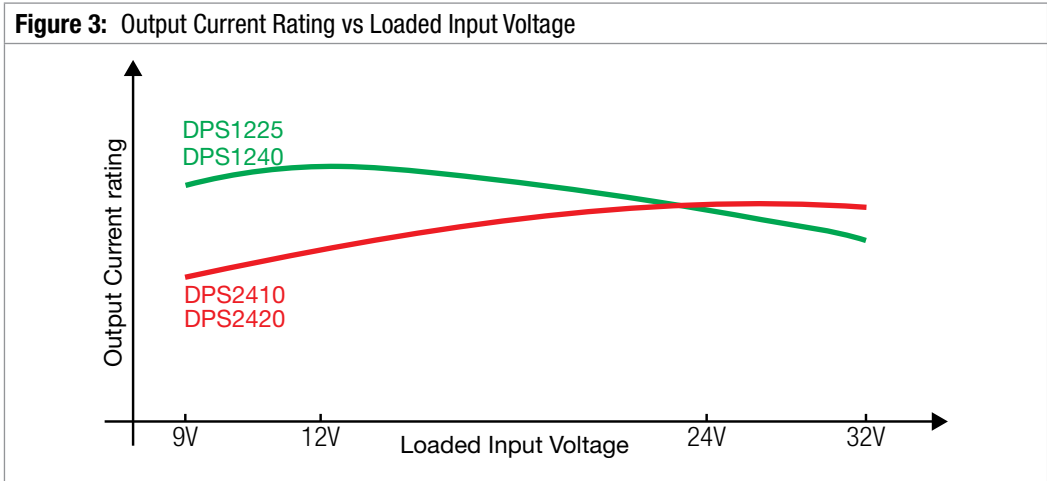

4 PRODUCT FUNCTION

4.3 Error Codes

In the event of a fault with the unit, installation, input supply or output loads, both the External LED and ALL the LEDs on the unit will flash to indicate the fault type. Flashing sequences are described in the table below.

LED State	Description
1 flash (1 flash followed by 3.5 second off)	Internal Hardware Fault
2 flash (2 flash followed by 3.5 second off)	Not Used
3 flash (3 flash followed by 3.5 second off)	Unit over temp fault
4 flash (4 flash followed by 3.5 second off)	Output over voltage
5 flash (5 flash followed by 3.5 second off)	Not Used
6 flash (6 flash followed by 3.5 second off)	Input over voltage
7 flash (7 flash followed by 3.5 second off)	Reverse polarity

NOTE: The unit will operate optimally below 55°C (131°F) with good airflow. At higher temperatures the unit will de-rate output current.

NOTE: Appropriate connections must be made to the wires with continuous current ratings as per the specifications table on page 4.

5 INSTALLATION

The DPS cannot be installed in direct heat environments such as the vehicles engine bay, the DPS performs at its best when the unit is mounted to the chassis for external heat sinking.

The DPS1225/DPS1240/DPS2410/DPS2420 has 6 wires and should be installed as described over the following pages.

5.1 RED wire — Input Source Positive

The RED wire should be connected to the positive input from the vehicle's starter battery.

Appropriate size fuses should be used as per the specifications table on page 4.

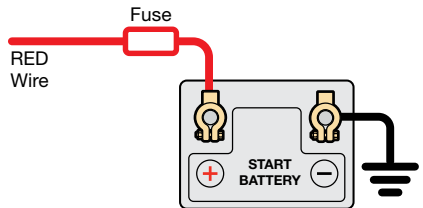

5 INSTALLATION

5.2 BLUE wire — Ignition Control

The BLUE wire should be connected to the vehicle's ignition or, if required, a dedicated ON/OFF switch.

When connected in this way, the power supply will only run the connected loads when the vehicle ignition is ON, guaranteeing that the power supply will not drain the start battery.

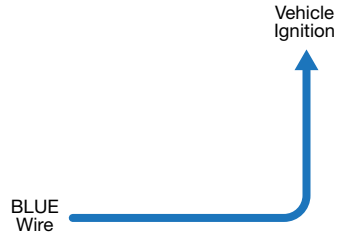

5.3 ORANGE wire — Output Voltage Select

The ORANGE wire is used to select the output voltage. This is achieved by connecting in the following way:

PROFILE A

For 12.0 V output on the DPS1225/DPS1240 or 24.0 V output on the DPS2410/DPS2420, leave the ORANGE wire disconnected.



PROFILE B

For 13.7 V output on the DPS1225/DPS1240 or 27.4 V output on the DPS2410/DPS2420, connect the ORANGE wire to Common Ground.



PROFILE C

For 14.5 V output on the DPS1225/DPS1240 or 29.0 V output on the DPS2410/DPS2420, connect the ORANGE wire to the RED wire (Input source positive).

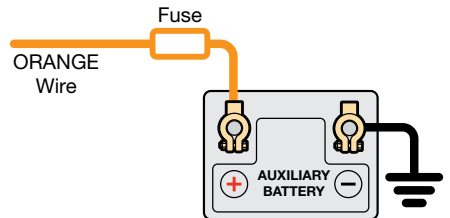

5 INSTALLATION

5.4 BROWN wire — Output load Positive

The BROWN wire should be connected to the output load's positive terminal. This should be a maximum of 1 m (3.3') in cable length from the DPS. Appropriate size fuses should be used as per the specifications table on page 4

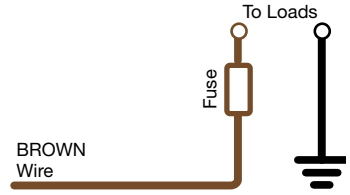

5.5 BLACK wire — Common Ground

The BLACK wire should be connected to a ground point that is common to both the start battery and the load. This point may be on the chassis of the vehicle or on the chassis of the trailer depending on your installation requirements.



5.6 GREEN wire — Optional External LED

The GREEN wire is provided to optionally connect an external indicator LED which can be mounted away from the unit (for example on the vehicle's dashboard). The DPS will limit the current supply by the GREEN wire to 6 mA so a standard green LED can be connected directly between the GREEN wire and the common ground. An LED with a series resistor can also be used but the resistor value should be less than or equal to 1000 Ohms (an LED with a built-in 1000 Ohm series resistor is typically referred to as a "12Volt LED").

Connect the positive lead of the LED to the green wire, and the negative lead to the common ground.

This LED will illuminate constantly when the DPS is supplying power, it will flash a fault code if the DPS has detected an error.

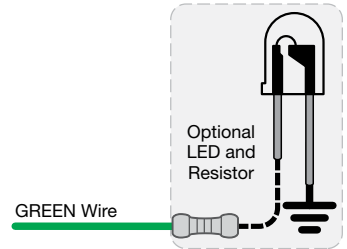

5.7 Earth Isolation

If the DPS is installed on a vehicle fitted with an earth isolation switch, the BLACK wire must run to chassis earth/ground and NOT the supply battery's negative post. This ensures that the DPS is also disconnected when the isolation switch is activated.

5 INSTALLATION

5.8 Cable sizing

Below is a table outlining the required cable size for a given cable install length. Always choose a wire diameter equal to or greater than what is specified below.

Part Number	Cable Install Length		Recommended Wire Size (mm ²)	Nearest Equivalent B&S, BAE, AWG
	1 – 5 m	3 – 16'		
DPS1225/ DPS2410	1 – 5 m	3 – 16'	7.71	8
	5 – 9 m	16 – 30'	13.56	6
DPS1240/ DPS2420	1 – 5 m	3 – 16'	13.56	6
	5 – 9 m	16 – 30'	20.28	4

5.9 Wiring

The heavy gauge wires on the DPS1225, DPS1240, DPS2410 and DPS2420 unit carry peak currents of up to 40 A and it is important to make a good, low resistance, electrical connection that will not degrade over time. Failure to make a good, reliable contact may result in breakdown of the wire insulation and cause a short circuit, or worst case a fire. We recommend that this activity be undertaken by an appropriately trained person.

REDARC recommends using a soldered butt splice crimp connection that is covered with heatshrink. Do not use standard red/ blue/yellow blade connections as they are not rated for either the current required or gauge of wire supplied on the unit.

Crimping provides good mechanical connection; soldering provides a long lasting electrical connection and forming of the heatshrink will reduce the risk of shorting/contact with your vehicle chassis.

Figure 4: Ensure Good Wiring Connection

Crimp both wires to the butt splice using single-indent type crimpers. Fold the cable over before inserting into the butt-splice as required. Single-indent crimpers should also be used on any lugs used.

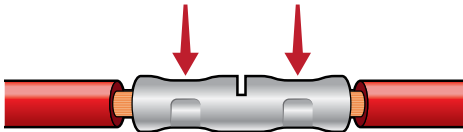

Solder the wires to the butt splice. Ensure that a good connection is made. Keep heatshrink away until after soldering is complete and has cooled.

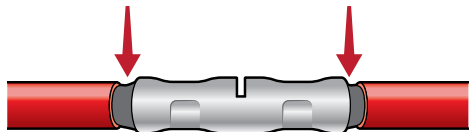
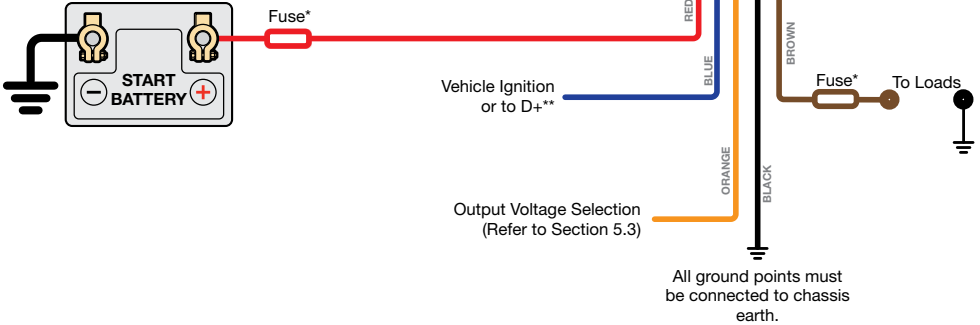

Figure 5: Standard 12V Input Setup

12V INPUT

Note: Power wires must be suitably sized (refer to Section 5.8) and must be crimped using an appropriate crimp tool.



* Fuse Ratings as per table on Page 4

** For vehicle ignition connection, connect to the ignition switched fuse in either the engine bay or the internal fuse box for the radio.

*** See Section 5.6 (page 9).

Figure 6: Standard 24V Input Setup

24V INPUT

Note: Power wires must be suitably sized (refer to Section 5.8) and must be crimped using an appropriate crimp tool.

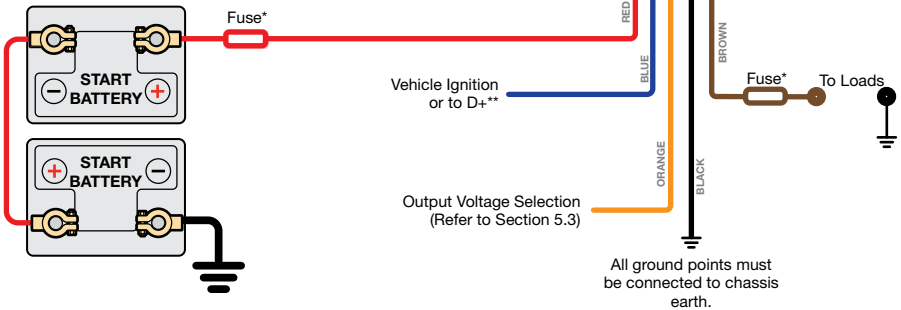

* Fuse Ratings as per table on Page 4

** For vehicle ignition connection, connect to the ignition switched fuse in either the engine bay or the internal fuse box for the radio.

*** See Section 5.6 (page 9).

5.10 Connecting in Parallel

It is possible to connect two DPS units in parallel to increase the current output. For example; two DPS1240s connected in parallel would produce a maximum of 80 A for a load. Parallel connection requires specific installation;

- Both DPS units must be mounted to the chassis of the vehicle for external heat sinking.
- The DPS units must be mounted close to each other.
- The RED, BROWN, BLACK, BLUE & ORANGE wires from both units must be joined to their matching colour with the same size and length cables.
- The input, output and earth wiring must be suitably sized to carry the constant high current.
- Suitably rated fuses must be used; Refer to page 4.

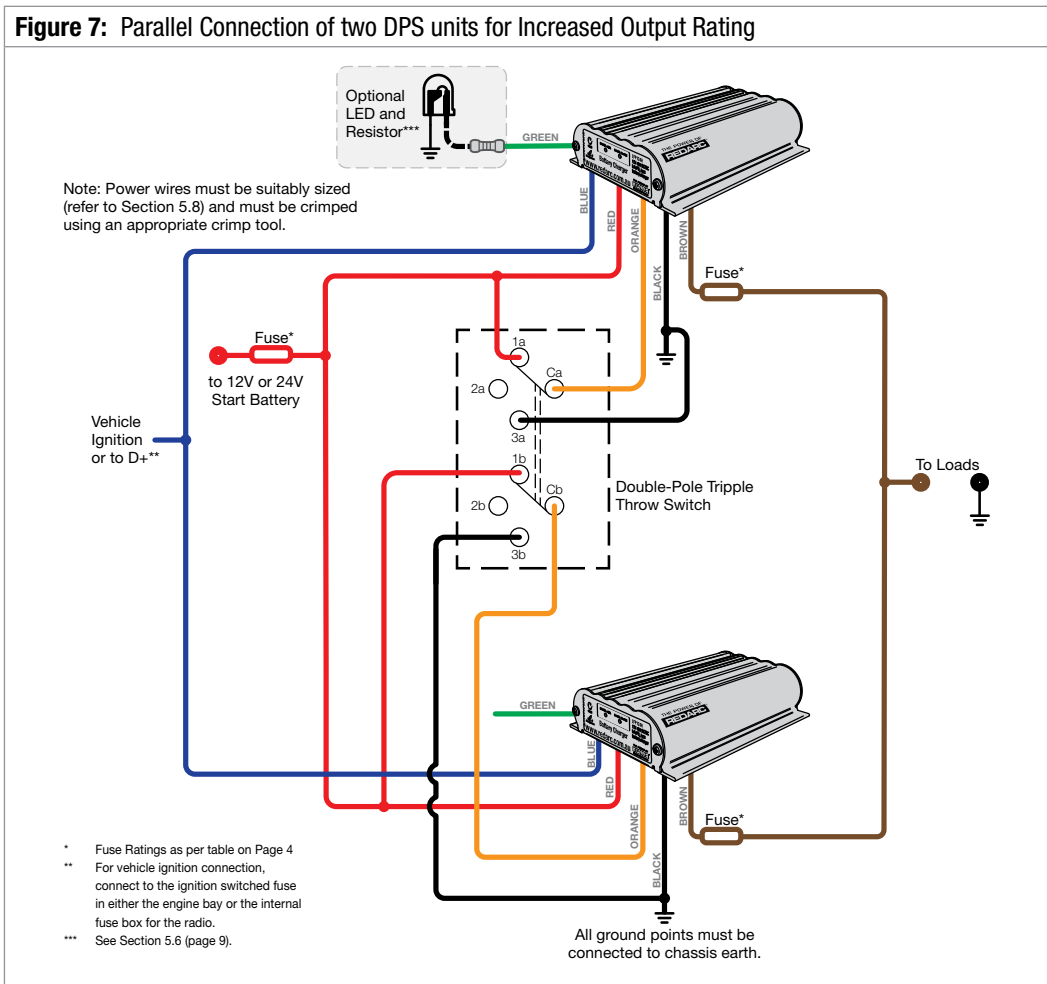

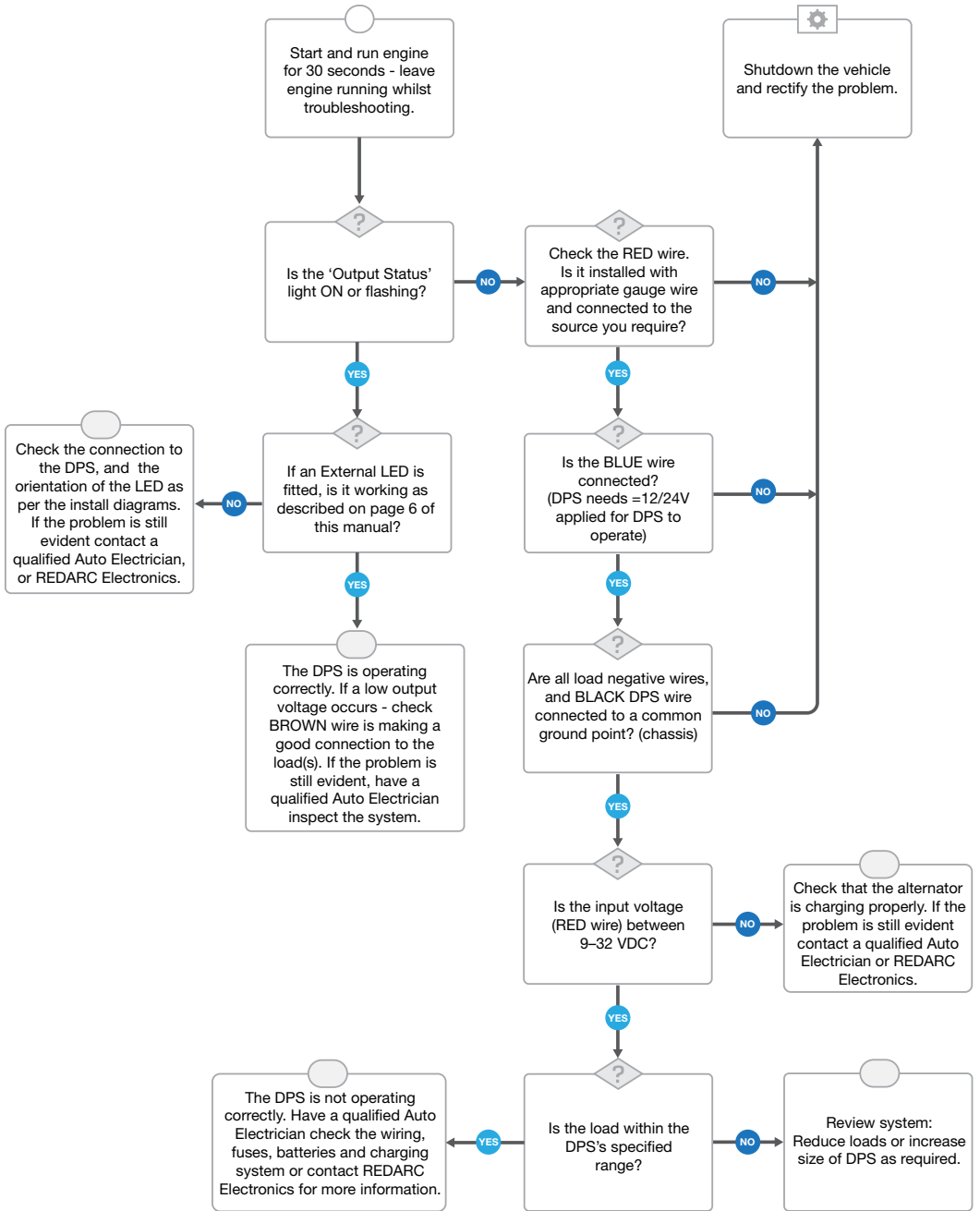

Limited Warranty

For full warranty terms and conditions, visit the link below or refer to the contact details applicable to your region.

Australia and New Zealand

www.redarc.com.au/warranty

REDARC Electronics Pty Ltd
23 Brodie Road (North),
Lonsdale SA 5160
Australia

Australia +61 8 8322 4848
New Zealand +64 9 222 1024

North America

www.redarcelectronics.com/warranty

REDARC Corporation
c/o Shallco, Inc.
308 Component Dr.
Smithfield, NC 27577
USA

USA +1 (704) 247 5150
Canada +1 (604) 260 5512
Mexico +52 (558) 526 2898
UK/Europe +44 (0)20 3930 8109

THE POWER OF

REDARC®

Tech Support

1300 REDARC (1300-733-272)

Head Office

+61 8 8322 4848

New Zealand

+64 9 222 1024

UK/Europe

+44 (0)20 3930 8109

USA

+1 (704) 247-5150

Canada

+1 (604) 260-5512

Mexico

+52 (558) 526-2898

www.redarcelectronics.com