

## **ARB PRADO WINCH/NON WINCH BUMPER TO SUIT GXL, VX AND GRANDE 2003 ONWARDS.**

**PART No**            **3921120**  
                         **5100050 Top Tube Kit**  
                         **5100160 Buffer Kit – With hole (required when fitting Top Tube)**  
                         **5100170 Buffer Kit – With no hole**

**FITTING KIT NO: 6172356**

### **WARNING**

**FOR VEHICLES EQUIPPED WITH SRS AIRBAG**  
**WHEN INSTALLED IN ACCORDANCE WITH THESE INSTRUCTIONS, THE FRONT PROTECTION BAR DOES NOT AFFECT OPERATION OF THE SRS AIRBAG.**

#### **TAKE NOTE OF THE FOLLOWING:**

- **THIS PRODUCT MUST BE INSTALLED EXACTLY AS PER THESE INSTRUCTIONS USING ONLY THE HARDWARE SUPPLIED.**
- **IN THE EVENT OF DAMAGE TO ANY BAR COMPONENT, CONTACT YOUR NEAREST AUTHORISED ARB STOCKIST. REPAIRS OR MODIFICATIONS TO THE IMPACT ABSORPTION SYSTEM MUST NOT BE ATTEMPTED.**
- **DO NOT USE THIS PRODUCT FOR ANY VEHICLE MAKE OR MODEL, OTHER THAN THOSE SPECIFIED BY ARB.**
- **DO NOT REMOVE LABELS FROM THIS BAR.**
- **THIS PRODUCT OR ITS FIXING MUST NOT BE MODIFIED IN ANY WAY.**

#### **OPTIONAL LIGHT SETS TO SUIT THIS PRODUCT:**

- ARB 6821201 Fog Light Kit Suit 3163015
- Up to IPF 900 SERIES FOG OR DRIVING LIGHT SETS

Suits warn 9000lb and 9500lb High Speed winches

**Tools Required For Bar Fitment: Basic Tool Kit, 17mm Tube Spanner, Cir-Clip pliers, Drill, 10mm and 13mm Drill Bits.**

USE.	PART NO.	QTY	DESCRIPTION
<b>Impact Absorber To Chassis</b>	3756571	1	Bracket Mount Assembly
	3756645R	1	Bracket Mount Brace RHS
	3756645L	1	Bracket Mount Brace LHS
	3193741	2	Captive Nut Plate
	6151306	2	Nut Cage M12 x 1.75
	6151255	10	Bolt M12 x 1.75 x 40mm
	6151189	6	Nut M12 x 1.75
	6151094	2	Bolt M12 x 1.25 x 30mm
	4581049	20	Washer Flat ½"
	4581050	12	Washer Spring ½"
5846401	4	Spacer 8mm	
<b>Bar To Impact Absorber</b>	6151304	6	Nut Cage M10 x 1.5
	6151232	8	Bolt M10 x 1.5 x 30mm
	4581040	10	Washer Flat M10 x 2mm
	4581048	8	Washer Spring M10
	6151026	2	Nut M10 x 1.5
<b>Stone Tray to Bar</b>	6522036	1	Stone Tray
	6151300	4	Nut Cage M6
	6151180	4	Bolt M6 x 20mm
	4581084	4	Washer Flat Panel M6
	4581036	4	Washer Spring M6
<b>Top Tube To Bar (5100050)</b>	6131516	1	Top Tube assembly
	6151255	2	Bolt M12 x 1.75 x 40mm
	4581049	2	Washer Flat ½"
	4581050	2	Washer Spring ½"
<b>Buffer To Bar (5100160 Required if fitting Top Tube)</b>	6151128	12	Flange Nut M6
	3162153	1	Buffer LHS
	3162154	1	Buffer RHS
<b>Buffer To Bar (5100170 Required if not fitting Top Tube)</b>	6151128	12	Flange Nut M6
	3162471L	1	Buffer LHS Sahara Bumper
	3162471R	1	Buffer RHS Sahara Bumper
<b>Buffer Lower To Bar</b>	6151128	5	Flange Nut M6
	3162155	1	Buffer Lower
<b>Indicators To Bar</b>	3163015	1	Kit Surround For Fog & Indicator Lights
	6821152	2	Turn signal / clearance light loom
	6821151L	1	Turn Signal/Clearance Light
	6821151R	1	Turn Signal/Clearance Light
<b>Licence Plate To Bar</b>	6151128	2	Nut Flange M6
	6781408	1	Tape Double sided
<b>Winch Cover To Bar</b>	6522030	1	Panel Winch Cover Prado
	6151256	2	Screw M6 S/S Button Head
	4581304	2	Washer Flat M6 S/S
	6151128	2	Nut Flange M6

<b>Winch To Bull Bar</b>	EG50	1	Rubber Grommet
	3756499	1	Bracket Control Box
	6151021	2	Bolt M8 x 20mm
	4581044	2	Washer Flat M8
	6151132	2	Nut Flange M8
	BLB560	2	Cable Black 560mm
	4581040	4	Washer Flat M10 x 2mm
	6151074	2	Bolt 1 ¼" x 3/8" UNC
<b>Washer Bottle Guard To Bar</b>	6522031L	1	Washer Bottle Guard For Sahara bar
	6522031R	1	Washer Bottle Guard For Sahara bar
	6151234	10	Bolt M8 x 25mm Black
	4581045	10	Washer Flat M8 Black
	6151132	10	Nut Flange M8
<b>Miscellaneous</b>	6821132	2	Rubber Grommet 3/8" ID
	6151128	2	Nut Flange M6
	180302	6	Cable Ties
	3162152	2	Plastic Plug 16mm DIA
	180701	6	Scotch Lock

## ASSEMBLY



1. Position the lower buffer and assemble using the M6 flange nuts. (Do not over tighten)



1. Fit the buffers. Buffer studs fit through the slots in the wings and the pan. Fasten using M6 flange nuts.

Note: This applies to both blank buffers and for those with the hole for optional frame.

**CAUTION: DO NOT OVER TIGHTEN THE M6 NUTS AS YOU RISK PULLING THE STUDS OUT OF THE BUFFERS.**



2. Fit cage nuts to the bull bar. M10's to the six square holes in the upright and M6's in the four square holes in the lower part of the pan. Also fit the M12 cage nuts to the captive nut assembly.



3. Remove front bumper cover from vehicle.
4. Remove front bumper reinforcing bar.
5. Remove side bumper supports from both guards.

NOTE: Retain the 8 flange nuts removed for fitment of the bull bar chassis mount.

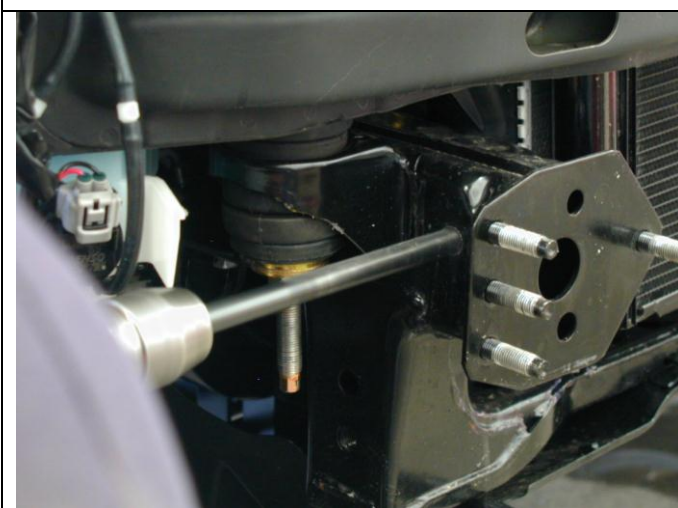

6. Using the 13mm drill bit, drill out the M8 captive nut in the top of the chassis on both sides of the vehicle.

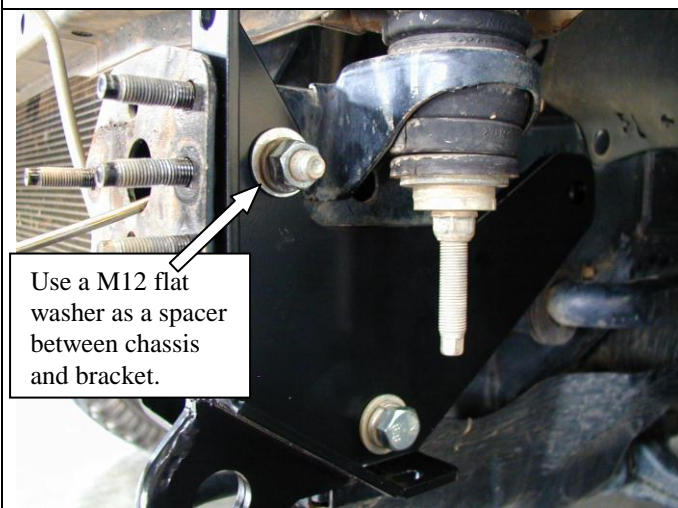

7. Fit the chassis mount braces to the vehicle using the M12 x 30mm fine pitched bolt, M12 spring and flat washers supplied in the lower hole. Use a M12 flat washer as a spacer between the brace and the chassis at the upper hole and fix with a M12 x 40mm bolt M12 spring and flat washers and M12 x 1.75 nut. Do not tighten the bolts.



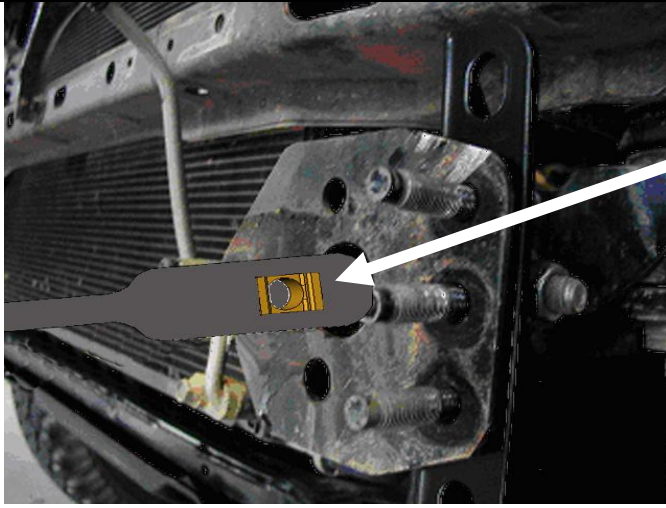

8. Insert the captive nut assembly through the front of the chassis and line it up with the hole at the end of the mount brace. Fix in place with the M12 x 1.75 x 40mm bolt, M12 flat and spring washers. Break off the end of the captive nut plate. Do not tighten yet.

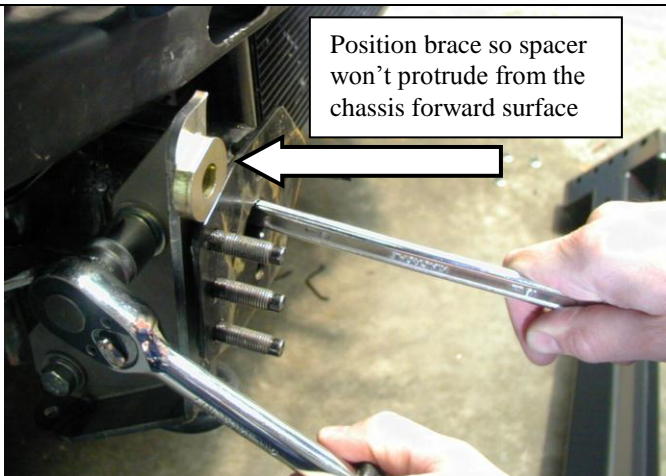

9. Hold the 8mm spacer against the chassis mount brace forward facing surface and position the brace so that the spacers sit just below the surface of the chassis front face. Tighten the bolts.

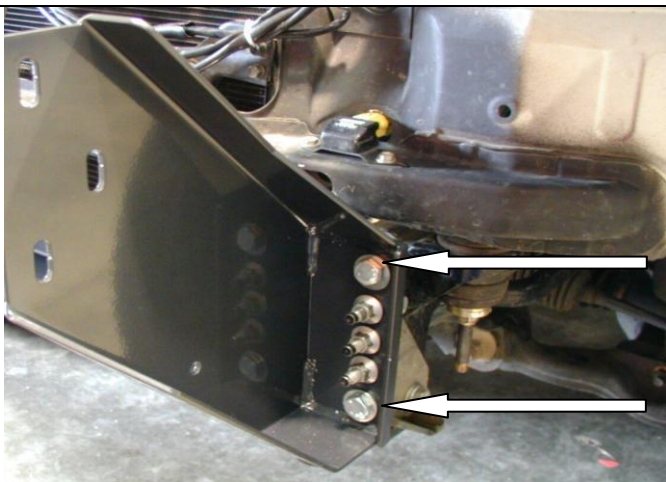

10. Fix the chassis mount bracket to the chassis mount brace using M12 x 40mm bolts, M12 spring and flat washers, the 8mm spacers and M12 x 1.75 nuts. Tighten bolts.

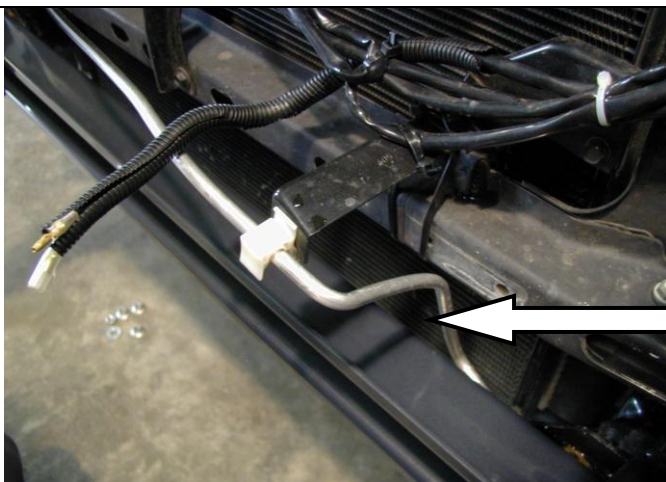

**CAUTION:** when fitting the Chassis mounting bracket carefully bend the air-conditioning pipe out of the way.

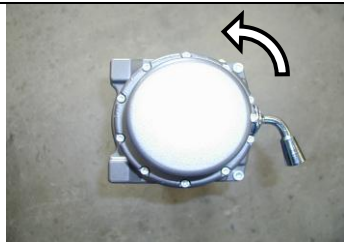

BEFORE ROTATION



AFTER ROTATION

11. For ease of access the winch gearbox handle needs to be rotated. To do this undo all the cap screws and carefully lift the gearbox clear of the winch body so as not to damage the gasket. (**Do not lift the gearbox more than a couple of millimetres**) Rotate the gearbox anti-clockwise three hole spaces. Re-fit the caps-crews.

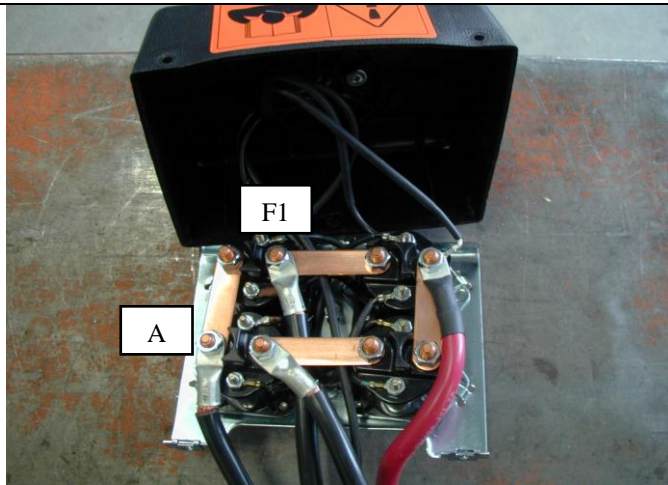

12. Remove the three screws from the control box and remove the cover.
13. Replace the two cables marked "A" and "F1" and replace them with the two cables (BLB560) supplied with the fitting kit. Label the cables the same as the original to assist in the wiring of the winch.

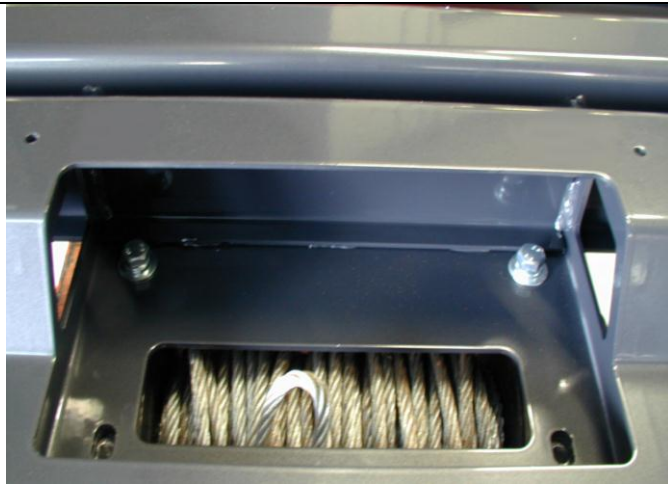

14. Place the winch on a table with the feet facing up and using an assistant, carefully lift the bar on top of the winch.
15. Attach the winch to the bar using two 1 1/2" x 3/8" bolts from the winch fitting kit, 3/8" spring washer and 3/8" flat washers in the top holes.

NOTE: Winch must be assembled so that the wire rope spools from the bottom and the gearbox is on the passenger side.



16. Position the roller fairlead, and remove the circlips from the lower of the verticle rollers and push the pins up to give access to the lower bolts.
17. Fix the roller fairlead to the bar using the 1 3/4" x 3/8" bolts, spring and flat washers.



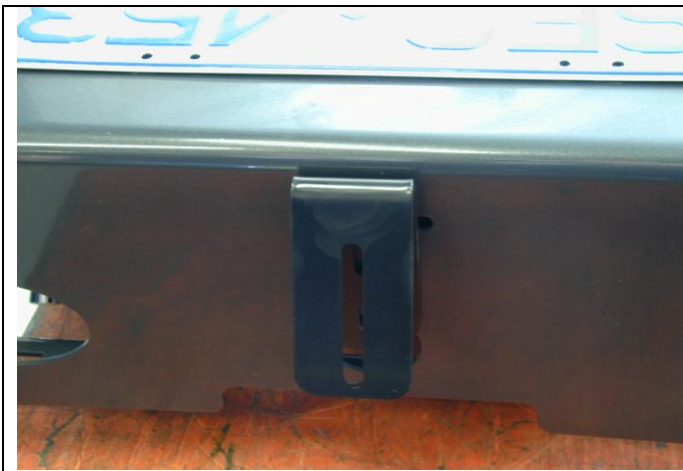

- Fit the control box bracket to the bar using two M8 x 20mm bolts, M8 flat washers and M8 flange nuts.



- Fit the control box to the control box bracket and connect the power cables to the winch as per the winch instructions.
- Connect the ground wire to the tension bar of the winch.

**CAUTION: Cable-tie all cables together and keep all cables clear of sharp edges and all moving parts.**



With winch



Without winch

- Place the double-sided tape along the top edge of the licence plate. Using the original licence plate screws and M6 flange nuts supplied in the fitting kit, attach the licence plate to the bar.

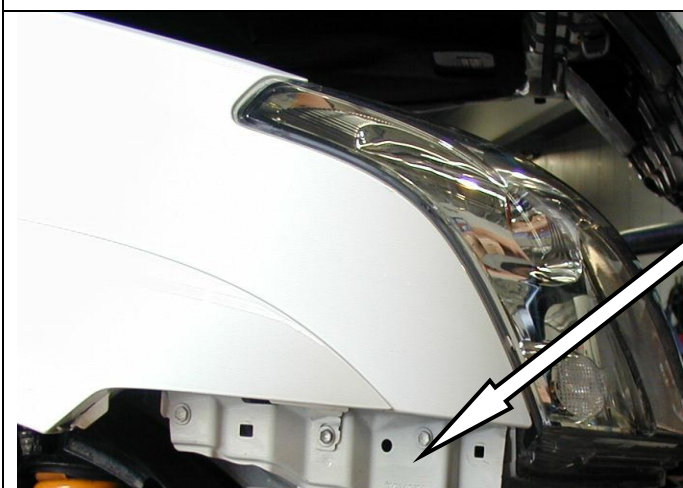

- Mask the area around the headlight and the front guard and paint the lower section under the front guard black. Paint this section on both sides black.

- With the help of an assistant position the bar on the chassis bracket and fix with six M10 x 30mm bolts, M10 spring and flat washers. Do not tighten the bolts yet.

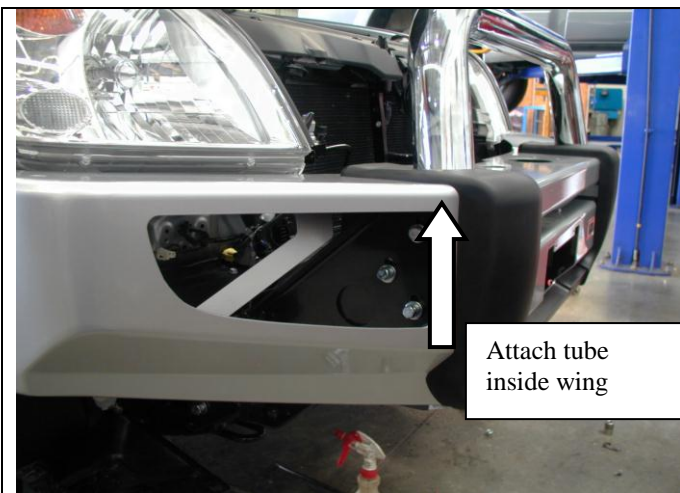

### If fitting Top Tube

24. Attach the tube to the bar by pushing through the holes in the buffers, fix using two M12 x 1.75 x 40mm bolts, 1/2" flat and spring washers.

#### NOTE:

Torque these M12 fasteners to 44Nm only (Critical)



25. Position the bar so that there is an even gap along the headlights and the guards of **25mm**. tighten all the bolts.

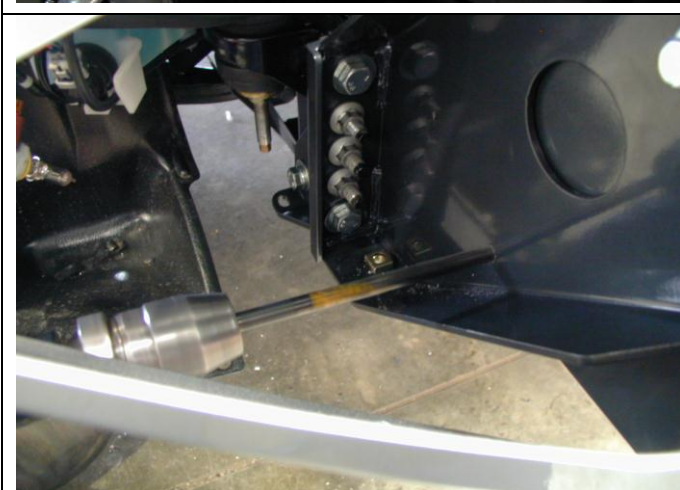

26. With the bar in position drill a 10mm hole through the upright on both sides using the hole in the chassis bracket as a guide.
27. Fix in place using two M10 x 30mm bolts, M10 spring washers, M10 Flat washers and M10 x 1.5 nuts.



28. Remove the front stone tray from the vehicle and remove the tags at the front of the tray. Refit the stone tray fixing in place with the rear bolts only.





29. Fit the bull bar stone tray by sliding the tray under the front of the vehicles original stone tray and fixing in place with the original bolts from the vehicles stone tray.
30. Fit the front of the stone tray to the bull bar with four M6 x 16mm bolts, M6 large panel washers and M6 spring washers.

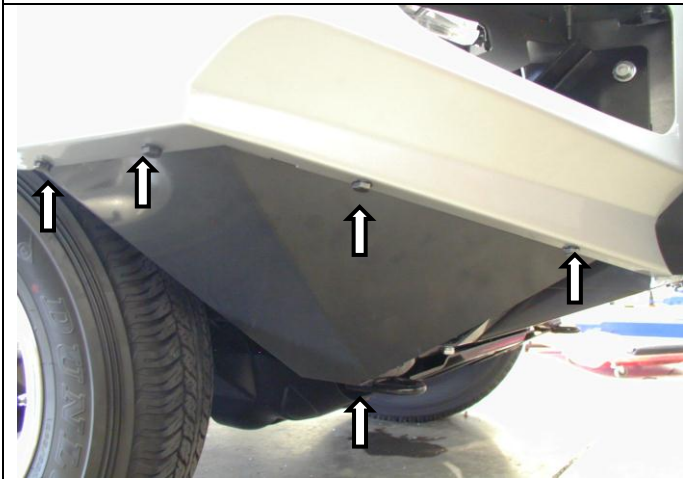

31. Fit the washer bottle guard with five M8 x 25mm black bolts, M8 black flat washers and M8 flange nuts.
  32. After fitting the washer bottle guard, trim the plastic inner guard liner so that it doesn't sit below the line of the washer bottle guard
  33. Attach the inner guard to the washer bottle guard with cable ties.
- Repeat step 33 for the opposite side.

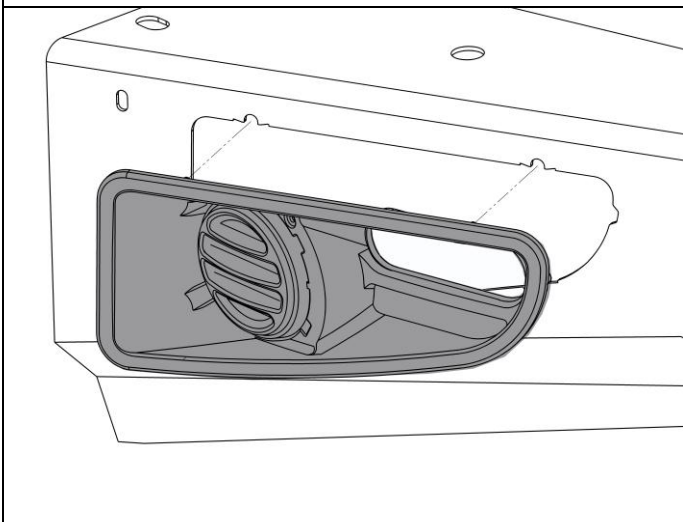

34. Assemble and install combination light surrounds (p/n 3163015) as per instructions no. 3786421 supplied with surround kit. Note: Optional fog lamps can be installed at this point as per fitting instruction no. 3783315 supplied with fog lamp kit no. 6821201.
  35. Wire the combination lamp to the vehicles indicator and clearance lamps.
- CAUTION: Cable-tie all cables together and keep all cables clear of sharp edges and all moving parts.**

When finished make sure that all bolts are tightened and that all wiring is clear of hot, sharp and moving parts.

Also supplied in the kit are two 3/8" rubber grommets and two 16mm plugs. The rubber grommets are for the two holes in the top pan if lights are being fitted. The two plastic plugs are for the holes in the top surface of the wings if no CB aerials are going to be connected.